

BOSCH

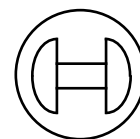

CAN Specification

Version 2.0

1991, Robert Bosch GmbH, Postfach 50, D-7000 Stuttgart 1

The document as a whole may be copied and distributed without restrictions. However, the usage of it in parts or as a whole in other documents needs the consent of Robert Bosch GmbH. Robert Bosch GmbH retains the right to make changes to this document without notice and does not accept any liability for errors.

Imported into Framemaker 4 by:

Chuck Powers, Motorola MCTG Multiplex Applications, April 5, 1995.



Recital

The acceptance and introduction of serial communication to more and more applications has led to requirements that the assignment of message identifiers to communication functions be standardized for certain applications. These applications can be realized with CAN more comfortably, if the address range that originally has been defined by 11 identifier bits is enlarged

Therefore a second message format ('extended format') is introduced that provides a larger address range defined by 29 bits. This will relieve the system designer from compromises with respect to defining well-structured naming schemes. Users of CAN who do not need the identifier range offered by the extended format, can rely on the conventional 11 bit identifier range ('standard format') further on. In this case they can make use of the CAN implementations that are already available on the market, or of new controllers that implement both formats.

In order to distinguish standard and extended format the first reserved bit of the CAN message format, as it is defined in CAN Specification 1.2, is used. This is done in such a way that the message format in CAN Specification 1.2 is equivalent to the standard format and therefore is still valid. Furthermore, the extended format has been defined so that messages in standard format and extended format can coexist within the same network.

This CAN Specification consists of two parts, with

- Part A describing the CAN message format as it is defined in CAN Specification 1.2;
- Part B describing both standard and extended message formats.

In order to be compatible with this CAN Specification 2.0 it is required that a CAN implementation be compatible with either Part A or Part B.

Note

CAN implementations that are designed according to part A of this or according to previous CAN Specifications, and CAN implementations that are designed according to part B of this specification can communicate with each other as long as it is not made use of the extended format.

PART A

1	INTRODUCTION.....	4
2	BASIC CONCEPTS.....	5
3	MESSAGE TRANSFER	10
3.1	Frame Types	10
3.1.1	DATA FRAME	10
3.1.2	REMOTE FRAME	15
3.1.3	ERROR FRAME.....	16
3.1.4	OVERLOAD FRAME.....	17
3.1.5	INTERFRAME SPACING.....	18
3.2	Definition of TRANSMITTER/RECEIVER	20
4	MESSAGE VALIDATION	21
5	CODING	22
6	ERROR HANDLING.....	23
6.1	Error Detection	23
6.2	Error Signalling.....	23
7	FAULT CONFINEMENT.....	24
8	BIT TIMING REQUIREMENTS	27
9	INCREASING CAN OSCILLATOR TOLERANCE.....	31
9.1	Protocol Modifications	31



1 INTRODUCTION

The Controller Area Network (CAN) is a serial communications protocol which efficiently supports distributed realtime control with a very high level of security.

Its domain of application ranges from high speed networks to low cost multiplex wiring. In automotive electronics, engine control units, sensors, anti-skid-systems, etc. are connected using CAN with bitrates up to 1 Mbit/s. At the same time it is cost effective to build into vehicle body electronics, e.g. lamp clusters, electric windows etc. to replace the wiring harness otherwise required.

The intention of this specification is to achieve compatibility between any two CAN implementations. Compatibility, however, has different aspects regarding e.g. electrical features and the interpretation of data to be transferred. To achieve design transparency and implementation flexibility CAN has been subdivided into different layers.

- the (CAN-) object layer
- the (CAN-) transfer layer
- the physical layer

The object layer and the transfer layer comprise all services and functions of the data link layer defined by the ISO/OSI model. The scope of the object layer includes

- finding which messages are to be transmitted
- deciding which messages received by the transfer layer are actually to be used,
- providing an interface to the application layer related hardware.

There is much freedom in defining object handling. The scope of the transfer layer mainly is the transfer protocol, i.e. controlling the framing, performing arbitration, error checking, error signalling and fault confinement. Within the transfer layer it is decided whether the bus is free for starting a new transmission or whether a reception is just starting. Also some general features of the bit timing are regarded as part of the transfer layer. It is in the nature of the transfer layer that there is no freedom for modifications.

The scope of the physical layer is the actual transfer of the bits between the different nodes with respect to all electrical properties. Within one network the physical layer, of course, has to be the same for all nodes. There may be, however, much freedom in selecting a physical layer.

The scope of this specification is to define the transfer layer and the consequences of the CAN protocol on the surrounding layers.

2 BASIC CONCEPTS

CAN has the following properties

- prioritization of messages
- guarantee of latency times
- configuration flexibility
- multicast reception with time synchronization
- system wide data consistency
- multimaster
- error detection and signalling
- automatic retransmission of corrupted messages as soon as the bus is idle again
- distinction between temporary errors and permanent failures of nodes and autonomous switching off of defect nodes

Layered Structure of a CAN Node

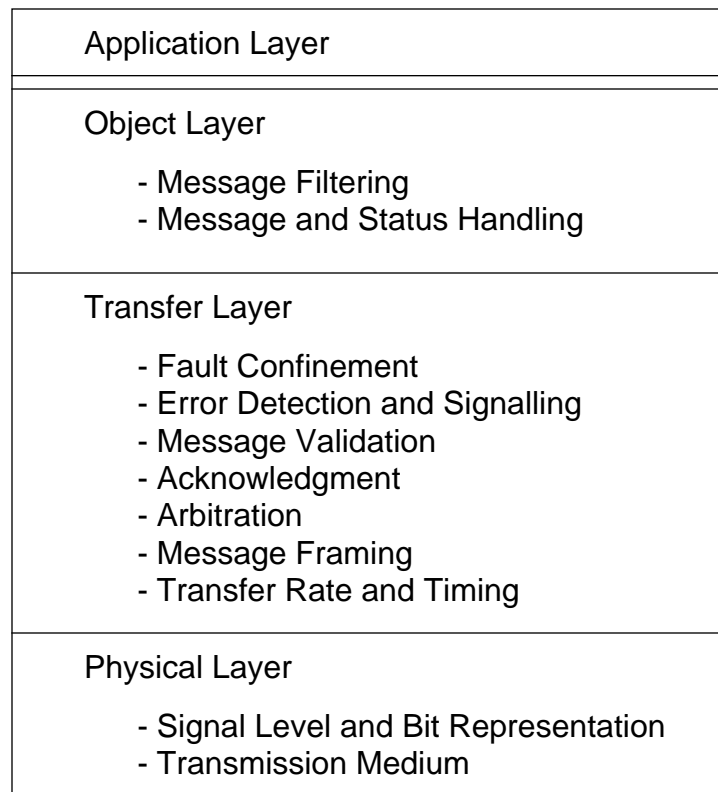



- The Physical Layer defines how signals are actually transmitted. Within this specification the physical layer is not defined so as to allow transmission medium and signal level implementations to be optimized for their application.
- The Transfer Layer represents the kernel of the CAN protocol. It presents messages received to the object layer and accepts messages to be transmitted from the object layer. The transfer layer is responsible for bit timing and synchronization, message framing, arbitration, acknowledgment, error detection and signalling, and fault confinement.
- The Object Layer is concerned with message filtering as well as status and message handling.

The scope of this specification is to define the transfer layer and the consequences of the CAN protocol on the surrounding layers.

Messages

Information on the bus is sent in fixed format messages of different but limited length (see section 3: Message Transfer). When the bus is free any connected unit may start to transmit a new message.

Information Routing

In CAN systems a CAN node does not make use of any information about the system configuration (e.g. station addresses). This has several important consequences.

System Flexibility: Nodes can be added to the CAN network without requiring any change in the software or hardware of any node and application layer.

Message Routing: The content of a message is named by an IDENTIFIER. The IDENTIFIER does not indicate the destination of the message, but describes the meaning of the data, so that all nodes in the network are able to decide by MESSAGE FILTERING whether the data is to be acted upon by them or not.

Multicast: As a consequence of the concept of MESSAGE FILTERING any number of nodes can receive and simultaneously act upon the same message.

Data Consistency: Within a CAN network it is guaranteed that a message is simultaneously accepted either by all nodes or by no node. Thus data consistency of a system is achieved by the concepts of multicast and by error handling.

Bit rate

The speed of CAN may be different in different systems. However, in a given system the bitrate is uniform and fixed.

Priorities

The IDENTIFIER defines a static message priority during bus access.

Remote Data Request

By sending a REMOTE FRAME a node requiring data may request another node to send the corresponding DATA FRAME. The DATA FRAME and the corresponding REMOTE FRAME are named by the same IDENTIFIER.

Multimaster

When the bus is free any unit may start to transmit a message. The unit with the message of higher priority to be transmitted gains bus access.

Arbitration

Whenever the bus is free, any unit may start to transmit a message. If 2 or more units start transmitting messages at the same time, the bus access conflict is resolved by bitwise arbitration using the IDENTIFIER. The mechanism of arbitration guarantees that neither information nor time is lost. If a DATA FRAME and a REMOTE FRAME with the same IDENTIFIER are initiated at the same time, the DATA FRAME prevails over the REMOTE FRAME. During arbitration every transmitter compares the level of the bit transmitted with the level that is monitored on the bus. If these levels are equal the unit may continue to send. When a 'recessive' level is sent and a 'dominant' level is monitored (see Bus Values), the unit has lost arbitration and must withdraw without sending one more bit.

Safety

In order to achieve the utmost safety of data transfer, powerful measures for error detection, signalling and self-checking are implemented in every CAN node.

Error Detection

For detecting errors the following measures have been taken:

- Monitoring (transmitters compare the bit levels to be transmitted with the bit levels detected on the bus)
- Cyclic Redundancy Check
- Bit Stuffing
- Message Frame Check

Performance of Error Detection

The error detection mechanisms have the following properties:

- all global errors are detected.
- all local errors at transmitters are detected.
- up to 5 randomly distributed errors in a message are detected.
- burst errors of length less than 15 in a message are detected.
- errors of any odd number in a message are detected.

Total residual error probability for undetected corrupted messages: less than

$$\text{message error rate} * 4.7 * 10^{-11}.$$

Error Signalling and Recovery Time

Corrupted messages are flagged by any node detecting an error. Such messages are aborted and will be retransmitted automatically. The recovery time from detecting an error until the start of the next message is at most 29 bit times, if there is no further error.

Fault Confinement

CAN nodes are able to distinguish short disturbances from permanent failures. Defective nodes are switched off.

Connections

The CAN serial communication link is a bus to which a number of units may be connected. This number has no theoretical limit. Practically the total number of units will be limited by delay times and/or electrical loads on the bus line.

Single Channel

The bus consists of a single channel that carries bits. From this data resynchronization information can be derived. The way in which this channel is implemented is not fixed in this specification. E.g. single wire (plus ground), two differential wires, optical fibres, etc.

Bus values

The bus can have one of two complementary logical values: 'dominant' or 'recessive'. During simultaneous transmission of 'dominant' and 'recessive' bits, the resulting bus value will be 'dominant'. For example, in case of a wired-AND implementation of the bus, the 'dominant' level would be represented by a logical '0' and the 'recessive' level by a logical '1'. Physical states (e.g. electrical voltage, light) that represent the logical levels are not given in this specification.

Acknowledgment

All receivers check the consistency of the message being received and will acknowledge a consistent message and flag an inconsistent message.

Sleep Mode / Wake-up

To reduce the system's power consumption, a CAN-device may be set into sleep mode without any internal activity and with disconnected bus drivers. The sleep mode is finished with a wake-up by any bus activity or by internal conditions of the system. On wake-up, the internal activity is restarted, although the transfer layer will be waiting for the system's oscillator to stabilize and it will then wait until it has synchronized itself to the bus activity (by checking for eleven consecutive 'recessive' bits), before the bus drivers are set to "on-bus" again.

In order to wake up other nodes of the system, which are in sleep-mode, a special wake-up message with the dedicated, lowest possible IDENTIFIER (rrr rrrd rrrr; r = 'recessive' d = 'dominant') may be used.

3 MESSAGE TRANSFER

3.1 Frame Types

Message transfer is manifested and controlled by four different frame types:

A DATA FRAME carries data from a transmitter to the receivers.

A REMOTE FRAME is transmitted by a bus unit to request the transmission of the DATA FRAME with the same IDENTIFIER.

An ERROR FRAME is transmitted by any unit on detecting a bus error.

An OVERLOAD FRAME is used to provide for an extra delay between the preceding and the succeeding DATA or REMOTE FRAMES.

DATA FRAMEs and REMOTE FRAMEs are separated from preceding frames by an INTERFRAME SPACE.

3.1.1 DATA FRAME

A DATA FRAME is composed of seven different bit fields:

START OF FRAME, ARBITRATION FIELD, CONTROL FIELD, DATA FIELD, CRC FIELD, ACK FIELD, END OF FRAME. The DATA FIELD can be of length zero.

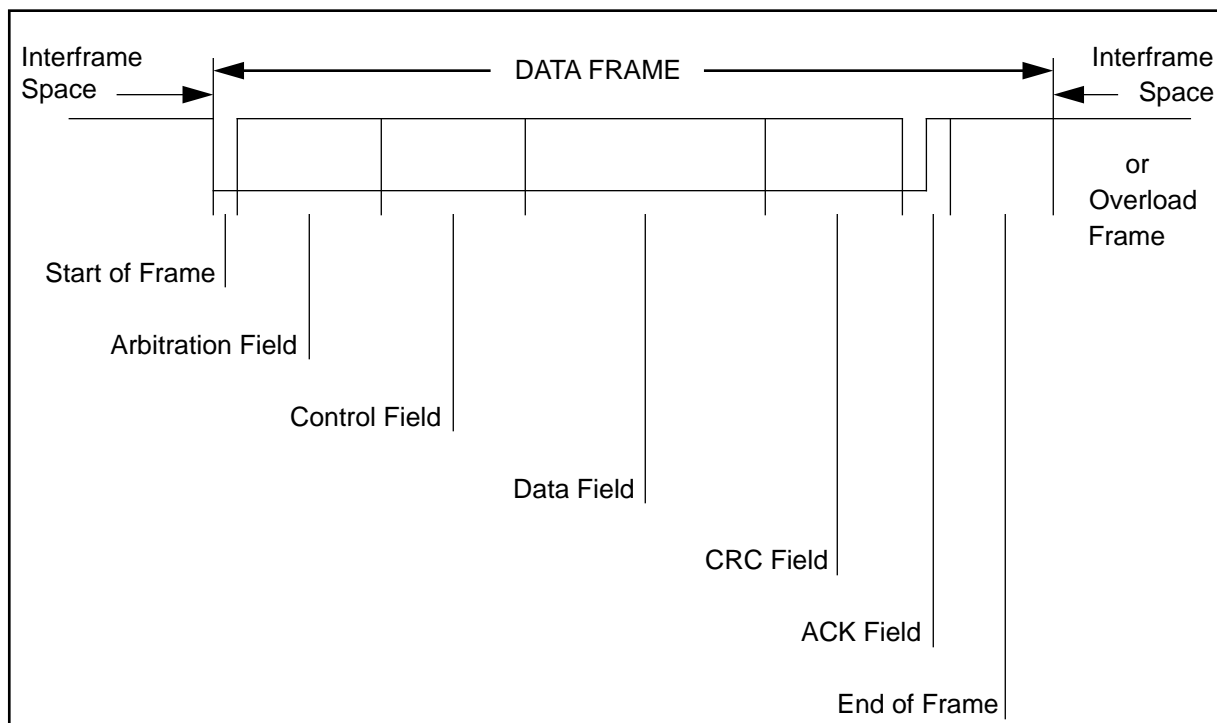

START OF FRAME

marks the beginning of DATA FRAMES and REMOTE FRAMEs. It consists of a single 'dominant' bit.

A station is only allowed to start transmission when the bus is idle (see BUS IDLE). All stations have to synchronize to the leading edge caused by START OF FRAME (see 'HARD SYNCHRONIZATION') of the station starting transmission first.

ARBITRATION FIELD

The ARBITRATION FIELD consists of the IDENTIFIER and the RTR-BIT.

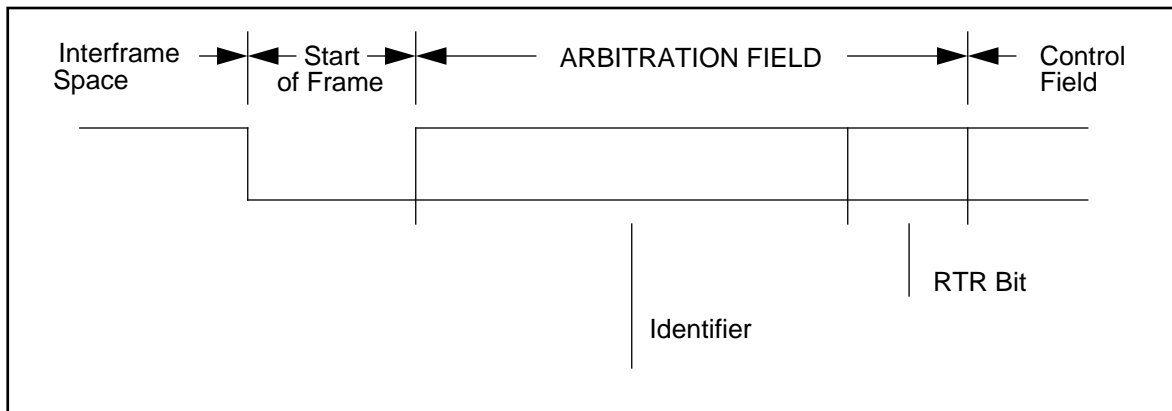
**IDENTIFIER**

The IDENTIFIER's length is 11 bits. These bits are transmitted in the order from ID-10 to ID-0. The least significant bit is ID-0. The 7 most significant bits (ID-10 - ID-4) must not be all 'recessive'.

RTR BIT**Remote Transmission Request BIT**

In DATA FRAMEs the RTR BIT has to be 'dominant'. Within a REMOTE FRAME the RTR BIT has to be 'recessive'.

CONTROL FIELD

The CONTROL FIELD consists of six bits. It includes the DATA LENGTH CODE and two bits reserved for future expansion. The reserved bits have to be sent 'dominant'. Receivers accept 'dominant' and 'recessive' bits in all combinations.

DATA LENGTH CODE

The number of bytes in the DATA FIELD is indicated by the DATA LENGTH CODE. This DATA LENGTH CODE is 4 bits wide and is transmitted within the CONTROL FIELD.

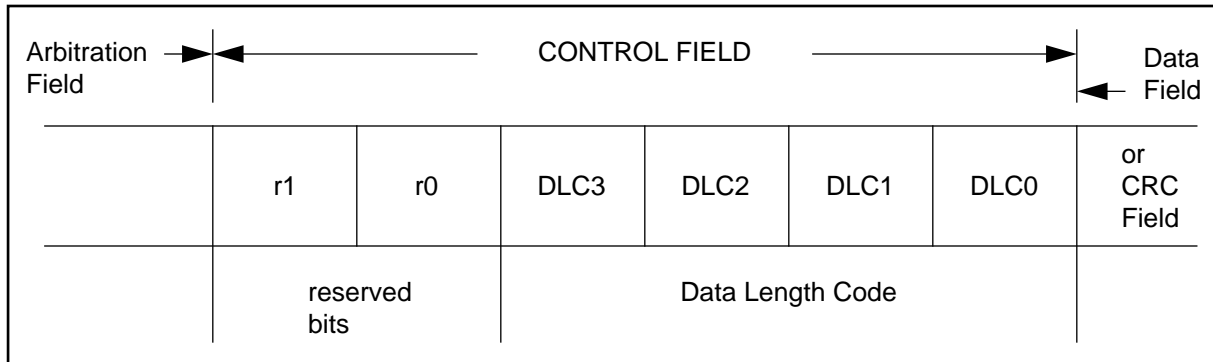

Coding of the number of data bytes by the DATA LENGTH CODE

abbreviations: d 'dominant'
 r 'recessive'

Number of Data Bytes	Data Length Code			
	DLC3	DLC2	DLC1	DLC0
0	d	d	d	d
1	d	d	d	r
2	d	d	r	d
3	d	d	r	r
4	d	r	d	d
5	d	r	d	r
6	d	r	r	d
7	d	r	r	r
8	r	d	d	d

DATA FRAME: admissible numbers of data bytes: {0,1,.....,7,8}.
Other values may not be used.

DATA FIELD

The DATA FIELD consists of the data to be transferred within a DATA FRAME. It can contain from 0 to 8 bytes, which each contain 8 bits which are transferred MSB first.

CRC FIELD

contains the CRC SEQUENCE followed by a CRC DELIMITER.

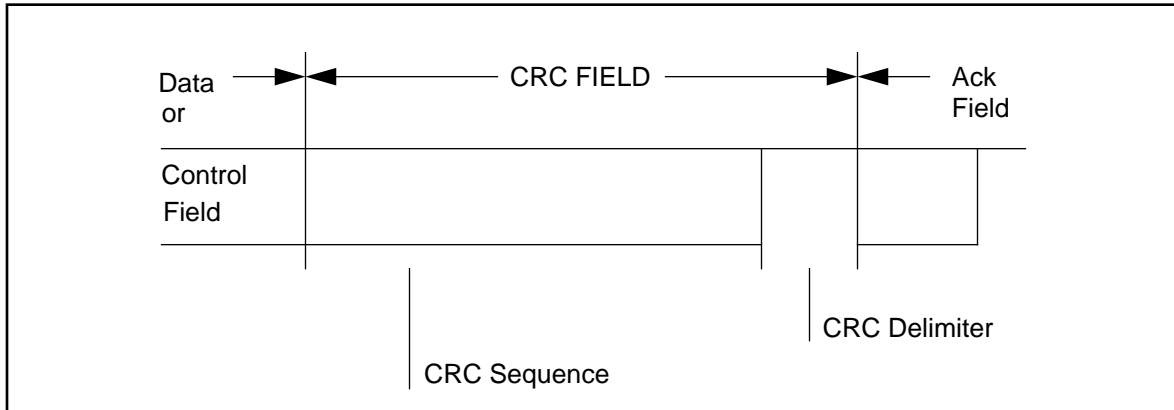

CRC SEQUENCE

The frame check sequence is derived from a cyclic redundancy code best suited for frames with bit counts less than 127 bits (BCH Code).

In order to carry out the CRC calculation the polynomial to be divided is defined as the polynomial, the coefficients of which are given by the destuffed bit stream consisting of START OF FRAME, ARBITRATION FIELD, CONTROL FIELD, DATA FIELD (if present) and, for the 15 lowest coefficients, by 0. This polynomial is divided (the coefficients are calculated modulo-2) by the generator-polynomial:

$$X^{15} + X^{14} + X^{10} + X^8 + X^7 + X^4 + X^3 + 1.$$

The remainder of this polynomial division is the CRC SEQUENCE transmitted over the bus. In order to implement this function, a 15 bit shift register CRC_RG(14:0) can be used. If NXTBIT denotes the next bit of the bit stream, given by the destuffed bit sequence from START OF FRAME until the end of the DATA FIELD, the CRC SEQUENCE is calculated as follows:

```

CRC_RG = 0; // initialize shift register
REPEAT
    CRCNXT = NXTBIT EXOR CRC_RG(14);
    CRC_RG(14:1) = CRC_RG(13:0); // shift left by
    CRC_RG(0) = 0; // 1 position

```

```
IF CRCNXT THEN
    CRC_RG(14:0) = CRC_RG(14:0) EXOR (4599hex);
ENDIF
UNTIL (CRC SEQUENCE starts or there is an ERROR condition)
```

After the transmission / reception of the last bit of the DATA FIELD, CRC_RG contains the CRC sequence.

CRC DELIMITER

The CRC SEQUENCE is followed by the CRC DELIMITER which consists of a single 'recessive' bit.

ACK FIELD

The ACK FIELD is two bits long and contains the ACK SLOT and the ACK DELIMITER. In the ACK FIELD the transmitting station sends two 'recessive' bits.

A RECEIVER which has received a valid message correctly, reports this to the TRANSMITTER by sending a 'dominant' bit during the ACK SLOT (it sends 'ACK').

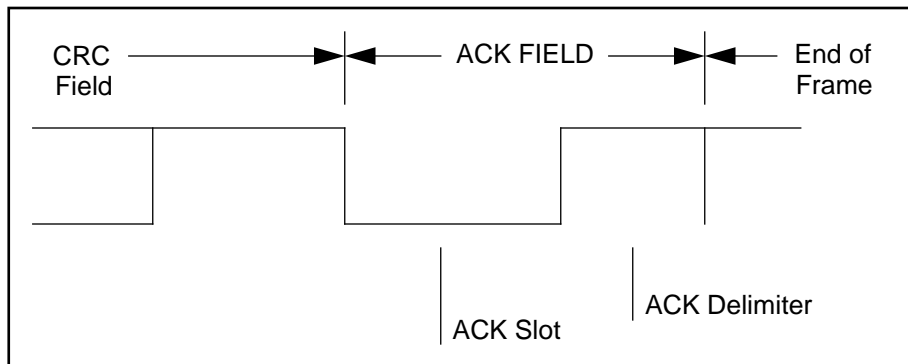

ACK SLOT

All stations having received the matching CRC SEQUENCE report this within the ACK SLOT by superscribing the 'recessive' bit of the TRANSMITTER by a 'dominant' bit.

ACK DELIMITER

The ACK DELIMITER is the second bit of the ACK FIELD and has to be a 'recessive' bit. As a consequence, the ACK SLOT is surrounded by two 'recessive' bits (CRC DELIMITER, ACK DELIMITER).

END OF FRAME

Each DATA FRAME and REMOTE FRAME is delimited by a flag sequence consisting of seven 'recessive' bits.

3.1.2 REMOTE FRAME

A station acting as a RECEIVER for certain data can initiate the transmission of the respective data by its source node by sending a REMOTE FRAME.

A REMOTE FRAME is composed of six different bit fields:

START OF FRAME, ARBITRATION FIELD, CONTROL FIELD, CRC FIELD, ACK FIELD, END OF FRAME.

Contrary to DATA FRAMEs, the RTR bit of REMOTE FRAMEs is 'recessive'. There is no DATA FIELD, independent of the values of the DATA LENGTH CODE which may be signed any value within the admissible range 0...8. The value is the DATA LENGTH CODE of the corresponding DATA FRAME.

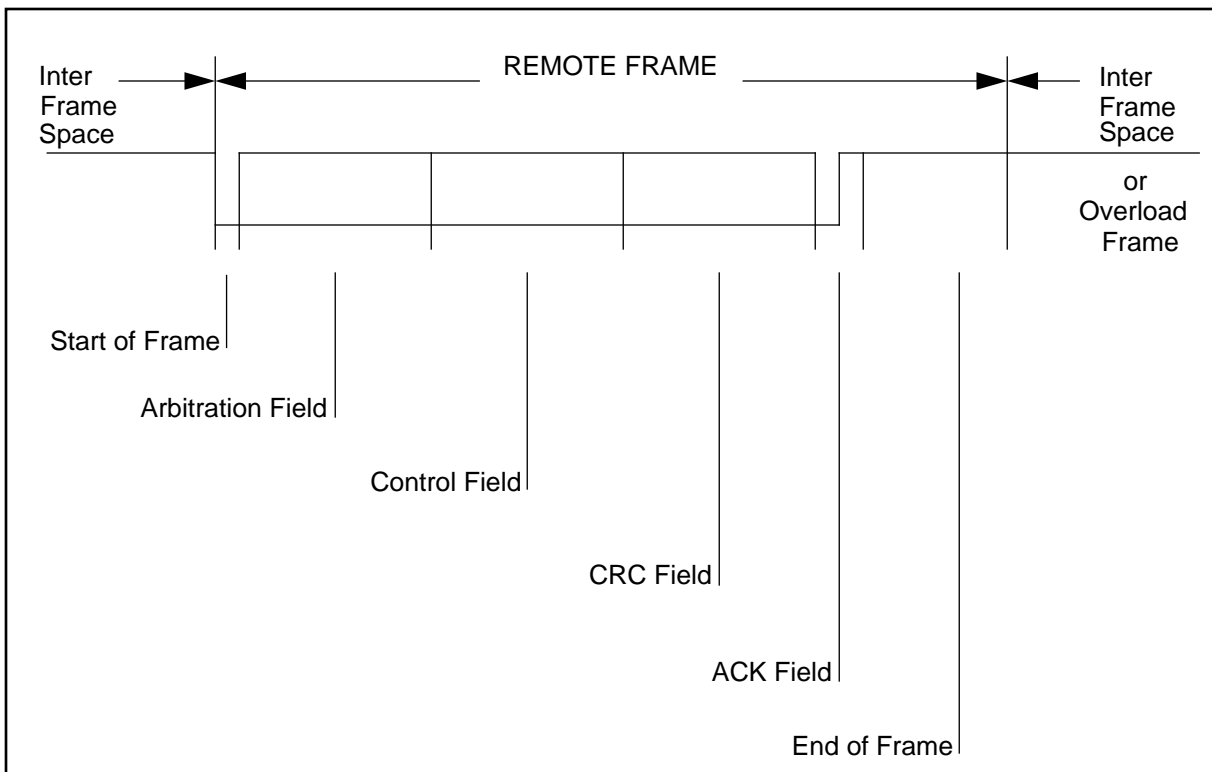

The polarity of the RTR bit indicates whether a transmitted frame is a DATA FRAME (RTR bit 'dominant') or a REMOTE FRAME (RTR bit 'recessive').

3.1.3 ERROR FRAME

The ERROR FRAME consists of two different fields. The first field is given by the superposition of ERROR FLAGS contributed from different stations. The following second field is the ERROR DELIMITER.

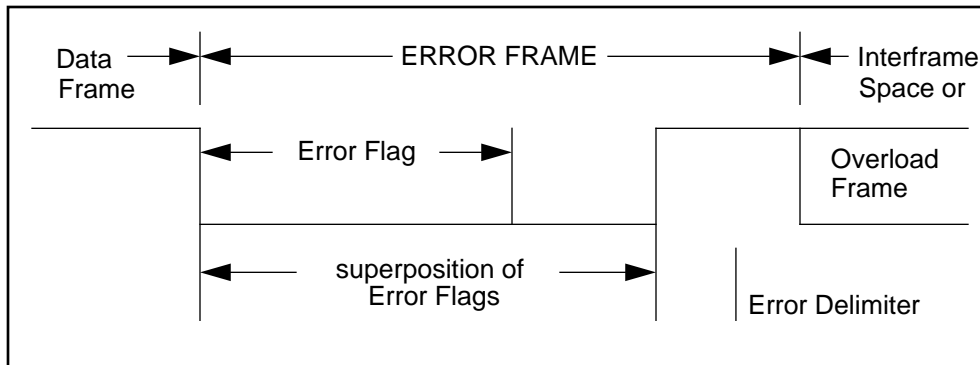

In order to terminate an ERROR FRAME correctly, an 'error passive' node may need the bus to be 'bus idle' for at least 3 bit times (if there is a local error at an 'error passive' receiver). Therefore the bus should not be loaded to 100%.

ERROR FLAG

There are 2 forms of an ERROR FLAG: an ACTIVE ERROR FLAG and a PASSIVE ERROR FLAG.

1. The ACTIVE ERROR FLAG consists of six consecutive 'dominant' bits.
2. The PASSIVE ERROR FLAG consists of six consecutive 'recessive' bits unless it is overwritten by 'dominant' bits from other nodes.

An 'error active' station detecting an error condition signals this by transmission of an ACTIVE ERROR FLAG. The ERROR FLAG's form violates the law of bit stuffing (see CODING) applied to all fields from START OF FRAME to CRC DELIMITER or destroys the fixed form ACK FIELD or END OF FRAME field. As a consequence, all other stations detect an error condition and on their part start transmission of an ERROR FLAG. So the sequence of 'dominant' bits which actually can be monitored on the bus results from a superposition of different ERROR FLAGS transmitted by individual stations. The total length of this sequence varies between a minimum of six and a maximum of twelve bits.

An 'error passive' station detecting an error condition tries to signal this by transmission of a PASSIVE ERROR FLAG. The 'error passive' station waits for six consecutive bits

of equal polarity, beginning at the start of the PASSIVE ERROR FLAG. The PASSIVE ERROR FLAG is complete when these 6 equal bits have been detected.

ERROR DELIMITER

The ERROR DELIMITER consists of eight 'recessive' bits.

After transmission of an ERROR FLAG each station sends 'recessive' bits and monitors the bus until it detects a 'recessive' bit. Afterwards it starts transmitting seven more 'recessive' bits.

3.1.4 OVERLOAD FRAME

The OVERLOAD FRAME contains the two bit fields OVERLOAD FLAG and OVERLOAD DELIMITER.

There are two kinds of OVERLOAD conditions, which both lead to the transmission of an OVERLOAD FLAG:

1. The internal conditions of a receiver, which requires a delay of the next DATA FRAME or REMOTE FRAME.
2. Detection of a 'dominant' bit during INTERMISSION.

The start of an OVERLOAD FRAME due to OVERLOAD condition 1 is only allowed to be started at the first bit time of an expected INTERMISSION, whereas OVERLOAD FRAMES due to OVERLOAD condition 2 start one bit after detecting the 'dominant' bit.

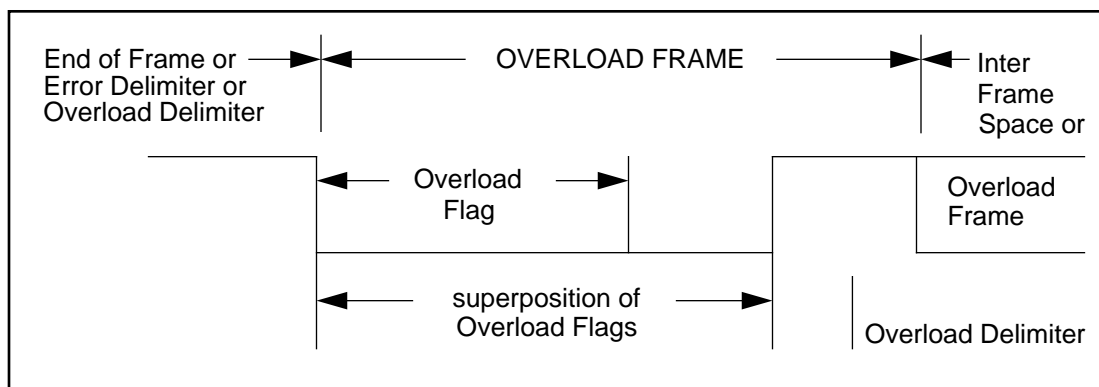

At most two OVERLOAD FRAMES may be generated to delay the next DATA or REMOTE FRAME.

**OVERLOAD FLAG**

consists of six 'dominant' bits. The overall form corresponds to that of the ACTIVE ERROR FLAG.

The OVERLOAD FLAG's form destroys the fixed form of the INTERMISSION field. As a consequence, all other stations also detect an OVERLOAD condition and on their part start transmission of an OVERLOAD FLAG. (In case that there is a 'dominant' bit detected during the 3rd bit of INTERMISSION locally at some node, the other nodes will not interpret the OVERLOAD FLAG correctly, but interpret the first of these six 'dominant' bits as START OF FRAME. The sixth 'dominant' bit violates the rule of bit stuffing causing an error condition).

OVERLOAD DELIMITER

consists of eight 'recessive' bits.

The OVERLOAD DELIMITER is of the same form as the ERROR DELIMITER. After transmission of an OVERLOAD FLAG the station monitors the bus until it detects a transition from a 'dominant' to a 'recessive' bit. At this point of time every bus station has finished sending its OVERLOAD FLAG and all stations start transmission of seven more 'recessive' bits in coincidence.

3.1.5 INTERFRAME SPACING

DATA FRAMES and REMOTE FRAMES are separated from preceding frames whatever type they are (DATA FRAME, REMOTE FRAME, ERROR FRAME, OVERLOAD FRAME) by a bit field called INTERFRAME SPACE. In contrast, OVERLOAD FRAMES and ERROR FRAMES are not preceded by an INTERFRAME SPACE and multiple OVERLOAD FRAMES are not separated by an INTERFRAME SPACE.

INTERFRAME SPACE

contains the bit fields INTERMISSION and BUS IDLE and, for 'error passive' stations, which have been TRANSMITTER of the previous message, SUSPEND TRANSMISSION.

For stations which are not 'error passive' or have been RECEIVER of the previous message:

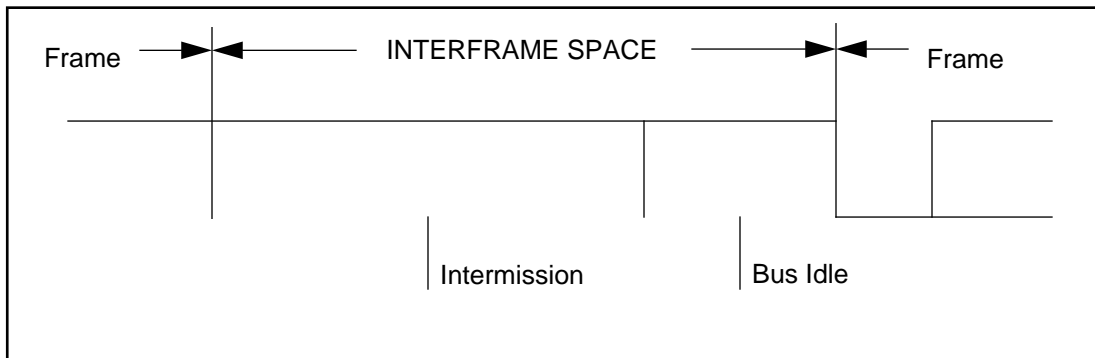

For 'error passive' stations which have been TRANSMITTER of the previous message:

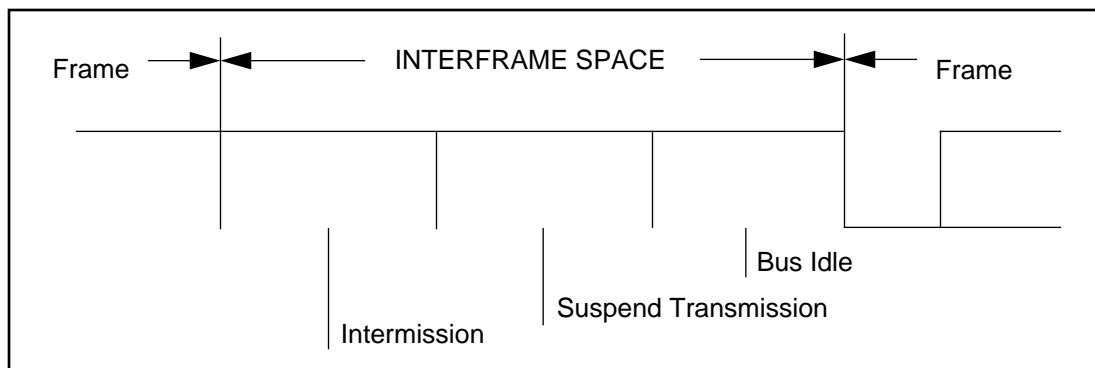

INTERMISSION

consists of three 'recessive' bits.

During INTERMISSION no station is allowed to start transmission of a DATA FRAME or REMOTE FRAME. The only action to be taken is signalling an OVERLOAD condition.

BUS IDLE

The period of BUS IDLE may be of arbitrary length. The bus is recognized to be free and any station having something to transmit can access the bus. A message, which is pending for transmission during the transmission of another message, is started in the first bit following INTERMISSION.

The detection of a 'dominant' bit on the bus is interpreted as a START OF FRAME.

SUSPEND TRANSMISSION

After an 'error passive' station has transmitted a message, it sends eight 'recessive' bits following INTERMISSION, before starting to transmit a further message or recognizing the bus to be idle. If meanwhile a transmission (caused by another station) starts, the station will become receiver of this message.

3.2 Definition of TRANSMITTER / RECEIVER**TRANSMITTER**

A unit originating a message is called "TRANSMITTER" of that message. The unit stays TRANSMITTER until the bus is idle or the unit loses ARBITRATION.

RECEIVER

A unit is called "RECEIVER" of a message, if it is not TRANSMITTER of that message and the bus is not idle.

4 MESSAGE VALIDATION

The point of time at which a message is taken to be valid, is different for the transmitter and the receivers of the message.

Transmitter:

The message is valid for the transmitter, if there is no error until the end of END OF FRAME. If a message is corrupted, retransmission will follow automatically and according to prioritization. In order to be able to compete for bus access with other messages, retransmission has to start as soon as the bus is idle.

Receivers:

The message is valid for the receivers, if there is no error until the last but one bit of END OF FRAME.



5 CODING

BIT STREAM CODING

The frame segments START OF FRAME, ARBITRATION FIELD, CONTROL FIELD, DATA FIELD and CRC SEQUENCE are coded by the method of bit stuffing. Whenever a transmitter detects five consecutive bits of identical value in the bit stream to be transmitted it automatically inserts a complementary bit in the actual transmitted bit stream.

The remaining bit fields of the DATA FRAME or REMOTE FRAME (CRC DELIMITER, ACK FIELD, and END OF FRAME) are of fixed form and not stuffed. The ERROR FRAME and the OVERLOAD FRAME are of fixed form as well and not coded by the method of bit stuffing.

The bit stream in a message is coded according to the Non-Return-to-Zero (NRZ) method. This means that during the total bit time the generated bit level is either 'dominant' or 'recessive'.

6 ERROR HANDLING

6.1 Error Detection

There are 5 different error types (which are not mutually exclusive):

- **BIT ERROR**
A unit that is sending a bit on the bus also monitors the bus. A BIT ERROR has to be detected at that bit time, when the bit value that is monitored is different from the bit value that is sent. An exception is the sending of a 'recessive' bit during the stuffed bit stream of the ARBITRATION FIELD or during the ACK SLOT. Then no BIT ERROR occurs when a 'dominant' bit is monitored. A TRANSMITTER sending a PASSIVE ERROR FLAG and detecting a 'dominant' bit does not interpret this as a BIT ERROR.
- **STUFF ERROR**
A STUFF ERROR has to be detected at the bit time of the 6th consecutive equal bit level in a message field that should be coded by the method of bit stuffing.
- **CRC ERROR**
The CRC sequence consists of the result of the CRC calculation by the transmitter. The receivers calculate the CRC in the same way as the transmitter. A CRC ERROR has to be detected, if the calculated result is not the same as that received in the CRC sequence.
- **FORM ERROR**
A FORM ERROR has to be detected when a fixed-form bit field contains one or more illegal bits.
- **ACKNOWLEDGMENT ERROR**
An ACKNOWLEDGMENT ERROR has to be detected by a transmitter whenever it does not monitor a 'dominant' bit during the ACK SLOT.

6.2 Error Signalling

A station detecting an error condition signals this by transmitting an ERROR FLAG. For an 'error active' node it is an ACTIVE ERROR FLAG, for an 'error passive' node it is a PASSIVE ERROR FLAG. Whenever a BIT ERROR, a STUFF ERROR, a FORM ERROR or an ACKNOWLEDGMENT ERROR is detected by any station, transmission of an ERROR FLAG is started at the respective station at the next bit.

Whenever a CRC ERROR is detected, transmission of an ERROR FLAG starts at the bit following the ACK DELIMITER, unless an ERROR FLAG for another condition has already been started.



7 FAULT CONFINEMENT

With respect to fault confinement a unit may be in one of three states:

- 'error active'
- 'error passive'
- 'bus off'

An 'error active' unit can normally take part in bus communication and sends an ACTIVE ERROR FLAG when an error has been detected.

An 'error passive' unit must not send an ACTIVE ERROR FLAG. It takes part in bus communication but when an error has been detected only a PASSIVE ERROR FLAG is sent. Also after a transmission, an 'error passive' unit will wait before initiating a further transmission. (See SUSPEND TRANSMISSION)

A 'bus off' unit is not allowed to have any influence on the bus. (E.g. output drivers switched off.)

For fault confinement two counts are implemented in every bus unit:

- 1) TRANSMIT ERROR COUNT
- 2) RECEIVE ERROR COUNT

These counts are modified according to the following rules:

(note that more than one rule may apply during a given message transfer)

1. When a RECEIVER detects an error, the RECEIVE ERROR COUNT will be increased by 1, except when the detected error was a BIT ERROR during the sending of an ACTIVE ERROR FLAG or an OVERLOAD FLAG.
2. When a RECEIVER detects a 'dominant' bit as the first bit after sending an ERROR FLAG the RECEIVE ERROR COUNT will be increased by 8.
3. When a TRANSMITTER sends an ERROR FLAG the TRANSMIT ERROR COUNT is increased by 8.

Exception 1:

If the TRANSMITTER is 'error passive' and detects an ACKNOWLEDGMENT



ERROR because of not detecting a 'dominant' ACK and does not detect a 'dominant' bit while sending its PASSIVE ERROR FLAG.

Exception 2:

If the TRANSMITTER sends an ERROR FLAG because a STUFF ERROR occurred during ARBITRATION whereby the STUFFBIT is located before the RTR bit, and should have been 'recessive', and has been sent as 'recessive' but monitored as 'dominant'.

In exceptions 1 and 2 the TRANSMIT ERROR COUNT is not changed.

4. If an TRANSMITTER detects a BIT ERROR while sending an ACTIVE ERROR FLAG or an OVERLOAD FLAG the TRANSMIT ERROR COUNT is increased by 8.
5. If an RECEIVER detects a BIT ERROR while sending an ACTIVE ERROR FLAG or an OVERLOAD FLAG the RECEIVE ERROR COUNT is increased by 8.
6. Any node tolerates up to 7 consecutive 'dominant' bits after sending an ACTIVE ERROR FLAG, PASSIVE ERROR FLAG or OVERLOAD FLAG. After detecting the 14th consecutive 'dominant' bit (in case of an ACTIVE ERROR FLAG or an OVERLOAD FLAG) or after detecting the 8th consecutive 'dominant' bit following a PASSIVE ERROR FLAG, and after each sequence of additional eight consecutive 'dominant' bits every TRANSMITTER increases its TRANSMIT ERROR COUNT by 8 and every RECEIVER increases its RECEIVE ERROR COUNT by 8.
7. After the successful transmission of a message (getting ACK and no error until END OF FRAME is finished) the TRANSMIT ERROR COUNT is decreased by 1 unless it was already 0.
8. After the successful reception of a message (reception without error up to the ACK SLOT and the successful sending of the ACK bit), the RECEIVE ERROR COUNT is decreased by 1, if it was between 1 and 127. If the RECEIVE ERROR COUNT was 0, it stays 0, and if it was greater than 127, then it will be set to a value between 119 and 127.
9. A node is 'error passive' when the TRANSMIT ERROR COUNT equals or exceeds 128, or when the RECEIVE ERROR COUNT equals or exceeds 128. An error condition letting a node become 'error passive' causes the node to send an ACTIVE ERROR FLAG.



10. A node is 'bus off' when the TRANSMIT ERROR COUNT is greater than or equal to 256.
11. An 'error passive' node becomes 'error active' again when both the TRANSMIT ERROR COUNT and the RECEIVE ERROR COUNT are less than or equal to 127.
12. An node which is 'bus off' is permitted to become 'error active' (no longer 'bus off') with its error counters both set to 0 after 128 occurrence of 11 consecutive 'recessive' bits have been monitored on the bus.

Note:

An error count value greater than about 96 indicates a heavily disturbed bus. It may be of advantage to provide means to test for this condition.

Note:**Start-up / Wake-up:**

If during start-up only 1 node is online, and if this node transmits some message, it will get no acknowledgment, detect an error and repeat the message. It can become 'error passive' but not 'bus off' due to this reason.

8 BIT TIMING REQUIREMENTS

NOMINAL BIT RATE

The Nominal Bit Rate is the number of bits per second transmitted in the absence of resynchronization by an ideal transmitter.

NOMINAL BIT TIME

$$\text{NOMINAL BIT TIME} = 1 / \text{NOMINAL BIT RATE}$$

The Nominal Bit Time can be thought of as being divided into separate non-overlapping time segments. These segments

- SYNCHRONIZATION SEGMENT (SYNC_SEG)
- PROPAGATION TIME SEGMENT (PROP_SEG)
- PHASE BUFFER SEGMENT1 (PHASE_SEG1)
- PHASE BUFFER SEGMENT2 (PHASE_SEG2)

form the bit time as shown in figure 1.

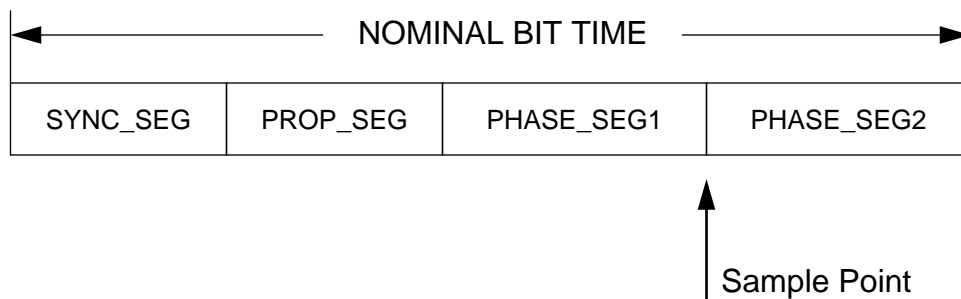

Fig. 1 Partition of the Bit Time

SYNC_SEG

This part of the bit time is used to synchronize the various nodes on the bus. An edge is expected to lie within this segment.

PROP_SEG

This part of the bit time is used to compensate for the physical delay times within the network.

It is twice the sum of the signal's propagation time on the bus line, the input comparator delay, and the output driver delay.

PHASE SEG1, PHASE SEG2

These Phase-Buffer-Segments are used to compensate for edge phase errors. These segments can be lengthened or shortened by resynchronization.

SAMPLE POINT

The SAMPLE POINT is the point of time at which the bus level is read and interpreted as the value of that respective bit. It's location is at the end of PHASE_SEG1.

INFORMATION PROCESSING TIME

The INFORMATION PROCESSING TIME is the time segment starting with the SAMPLE POINT reserved for calculation the subsequent bit level.

TIME QUANTUM

The TIME QUANTUM is a fixed unit of time derived from the oscillator period. There exists a programmable prescaler, with integral values, ranging at least from 1 to 32. Starting with the MINIMUM TIME QUANTUM, the TIME QUANTUM can have a length of

$$\text{TIME QUANTUM} = m * \text{MINIMUM TIME QUANTUM}$$

with m the value of the prescaler.

Length of Time Segments

- SYNC_SEG is 1 TIME QUANTUM long.
- PROP_SEG is programmable to be 1,2,...,8 TIME QUANTA long.
- PHASE_SEG1 is programmable to be 1,2,...,8 TIME QUANTA long.
- PHASE_SEG2 is the maximum of PHASE_SEG1 and the INFORMATION PROCESSING TIME
- The INFORMATION PROCESSING TIME is less than or equal to 2 TIME QUANTA long.

The total number of TIME QUANTA in a bit time has to be programmable at least from 8 to 25.

SYNCHRONIZATION

HARD SYNCHRONIZATION

After a HARD SYNCHRONIZATION the internal bit time is restarted with SYNC_SEG. Thus HARD SYNCHRONIZATION forces the edge which has caused the HARD SYNCHRONIZATION to lie within the SYNCHRONIZATION SEGMENT of the restarted bit time.

RESYNCHRONIZATION JUMP WIDTH

As a result of RESYNCHRONIZATION PHASE_SEG1 may be lengthened or PHASE_SEG2 may be shortened. The amount of lengthening or shortening of the PHASE BUFFER SEGMENTS has an upper bound given by the RESYNCHRONIZATION JUMP WIDTH. The RESYNCHRONIZATION JUMP WIDTH shall be programmable between 1 and $\min(4, \text{PHASE_SEG1})$.

Clocking information may be derived from transitions from one bit value to the other. The property that only a fixed maximum number of successive bits have the same value provides the possibility of resynchronizing a bus unit to the bit stream during a frame. The maximum length between two transitions which can be used for resynchronization is 29 bit times.

PHASE ERROR of an edge

The PHASE ERROR of an edge is given by the position of the edge relative to SYNC_SEG, measured in TIME QUANTA. The sign of PHASE ERROR is defined as follows:

- $e = 0$ if the edge lies within SYNC_SEG.
- $e > 0$ if the edge lies before the SAMPLE POINT.
- $e < 0$ if the edge lies after the SAMPLE POINT of the previous bit.

RESYNCHRONIZATION

The effect of a RESYNCHRONIZATION is the same as that of a HARD SYNCHRONIZATION, when the magnitude of the PHASE ERROR of the edge which causes the RESYNCHRONIZATION is less than or equal to the programmed value of the RESYNCHRONIZATION JUMP WIDTH. When the magnitude of the PHASE ERROR is larger than the RESYNCHRONIZATION JUMP WIDTH,

- and if the PHASE ERROR is positive, then PHASE_SEG1 is lengthened by an amount equal to the RESYNCHRONIZATION JUMP WIDTH.
- and if the PHASE ERROR is negative, then PHASE_SEG2 is shortened by an amount equal to the RESYNCHRONIZATION JUMP WIDTH.

SYNCHRONIZATION RULES

HARD SYNCHRONIZATION and RESYNCHRONIZATION are the two forms of SYNCHRONIZATION. They obey the following rules:

1. Only one SYNCHRONIZATION within one bit time is allowed.
2. An edge will be used for SYNCHRONIZATION only if the value detected at the previous SAMPLE POINT (previous read bus value) differs from the bus value immediately after the edge.
3. HARD SYNCHRONIZATION is performed whenever there is a 'recessive' to 'dominant' edge during BUS IDLE.
4. All other 'recessive' to 'dominant' edges (and optionally 'dominant' to 'recessive' edges in case of low bit rates) fulfilling the rules 1 and 2 will be used for RESYNCHRONIZATION with the exception that a node transmitting a dominant bit will not perform a RESYNCHRONIZATION as a result of a 'recessive' to 'dominant' edge with a positive PHASE ERROR, if only 'recessive' to 'dominant' edges are used for resynchronization.

9 INCREASING CAN OSCILLATOR TOLERANCE

This section describes an upwards compatible modification of the CAN protocol, as specified in sections 1 to 8.

9.1 Protocol Modifications

In order to increase the maximum oscillator tolerance from the 0.5% currently possible to 1.5%, the following modifications, which are upwards compatible to the existing CAN specification, are necessary:

- [1] If a CAN node samples a dominant bit at the third bit of INTERMISSION, then it will interpret this bit as a START OF FRAME bit.
 - [2] If a CAN node has a message waiting for transmission and it samples a dominant bit at the third bit of INTERMISSION, it will interpret this as a START OF FRAME bit, and, with the next bit, start transmitting its message with the first bit of the IDENTIFIER without first transmitting a START OF FRAME bit and without becoming a receiver.
 - [3] If a CAN node samples a dominant bit at the eighth bit (the last bit) of an ERROR DELIMITER or OVERLOAD DELIMITER, it will, at the next bit, start transmitting an OVERLOAD FRAME (not an ERROR FRAME). The Error Counters will not be incremented.
 - [4] Only recessive to dominant edges will be used for synchronization.
- In agreement with the existing specification, the following rules are still valid.
- [5] All CAN controllers synchronize on the START OF FRAME bit with a hard synchronization.
 - [6] No CAN controller will send a START OF FRAME bit until it has counted three recessive bits of INTERMISSION.

This modifications allow a maximum oscillator tolerance of 1.58% and the use of a ceramic resonator at a bus speed of up to 125 Kbits/second. For the full bus speed range of the CAN protocol, still a quartz oscillator is required. The compatibility of the enhanced and the existing protocol is maintained, as long as:

- [7] CAN controllers with the enhanced and existing protocols, used in one and the same network, have all to be provided with a quartz oscillator.

The chip with the highest requirement for its oscillator accuracy determines the oscillator accuracy which is required from all the other nodes. Ceramic resonators can only be used when all the nodes in the network use the enhanced protocol.

PART B

1	INTRODUCTION.....	34
2	BASIC CONCEPTS.....	36
3	MESSAGE TRANSFER	42
3.1	Frame Formats.....	42
3.2	Frame Types	42
3.2.1	DATA FRAME	42
3.2.2	REMOTE FRAME	49
3.2.3	ERROR FRAME	50
3.2.4	OVERLOAD FRAME	51
3.2.5	INTERFRAME SPACING.....	53
3.3	Conformance with regard to Frame Formats	55
3.4	Definition of TRANSMITTER/RECEIVER	55
4	MESSAGE FILTERING.....	56
5	MESSAGE VALIDATION	57
6	CODING	58
7	ERROR HANDLING.....	59
7.1	Error Detection	59
7.2	Error Signalling.....	60
8	FAULT CONFINEMENT.....	61
9	OSCILLATOR TOLERANCE.....	64
10	BIT TIMING REQUIREMENTS	27

1 INTRODUCTION

The Controller Area Network (CAN) is a serial communications protocol which efficiently supports distributed realtime control with a very high level of security.

Its domain of application ranges from high speed networks to low cost multiplex wiring. In automotive electronics, engine control units, sensors, anti-skid-systems, etc. are connected using CAN with bitrates up to 1 Mbit/s. At the same time it is cost effective to build into vehicle body electronics, e.g. lamp clusters, electric windows etc. to replace the wiring harness otherwise required.

The intention of this specification is to achieve compatibility between any two CAN implementations. Compatibility, however, has different aspects regarding e.g. electrical features and the interpretation of data to be transferred. To achieve design transparency and implementation flexibility CAN has been subdivided into different layers according to the ISO/OSI Reference Model:

- the Data Link Layer
 - the Logical Link Control (LLC) sublayer
 - the Medium Access Control (MAC) sublayer
- the Physical Layer

Note that in previous versions of the CAN specification the services and functions of the LLC and MAC sublayers of the Data Link Layer had been described in layers denoted as 'object layer' and 'transfer layer'. The scope of the LLC sublayer is

- to provide services for data transfer and for remote data request,
- to decide which messages received by the LLC sublayer are actually to be accepted,
- to provide means for recovery management and overload notifications.

There is much freedom in defining object handling. The scope of the MAC sublayer mainly is the transfer protocol, i.e. controlling the Framing, performing Arbitration, Error Checking, Error Signalling and Fault Confinement. Within the MAC sublayer it is decided whether the bus is free for starting a new transmission or whether a reception is just starting. Also some general features of the bit timing are regarded as part of the MAC sublayer. It is in the nature of the MAC sublayer that there is no freedom for modifications.

The scope of the physical layer is the actual transfer of the bits between the different nodes with respect to all electrical properties. Within one network the physical layer, of

course, has to be the same for all nodes. There may be, however, much freedom in selecting a physical layer.

The scope of this specification is to define the MAC sublayer and a small part of the LLC sublayer of the Data Link Layer and to describe the consequences of the CAN protocol on the surrounding layers.

2 BASIC CONCEPTS

CAN has the following properties

- prioritization of messages
- guarantee of latency times
- configuration flexibility
- multicast reception with time synchronization
- system wide data consistency
- multimaster
- error detection and signalling
- automatic retransmission of corrupted messages as soon as the bus is idle again
- distinction between temporary errors and permanent failures of nodes and autonomous switching off of defect nodes

Layered Architecture of CAN according to the OSI Reference Model

- The Physical Layer defines how signals are actually transmitted and therefore deals with the description of Bit Timing, Bit Encoding, and Synchronization. Within this specification the Driver/Receiver Characteristics of the Physical Layer are not defined so as to allow transmission medium and signal level implementations to be optimized for their application.
- The MAC sublayer represents the kernel of the CAN protocol. It presents messages received from the LLC sublayer and accepts messages to be transmitted to the LLC sublayer. The MAC sublayer is responsible for Message Framing, Arbitration, Acknowledgment, Error Detection and Signalling. The MAC sublayer are supervised by a management entity called Fault Confinement which is self-checking mechanism for distinguishing short disturbances from permanent failures.
- The LLC sublayer is concerned with Message Filtering, Overload Notification and Recovery Management.

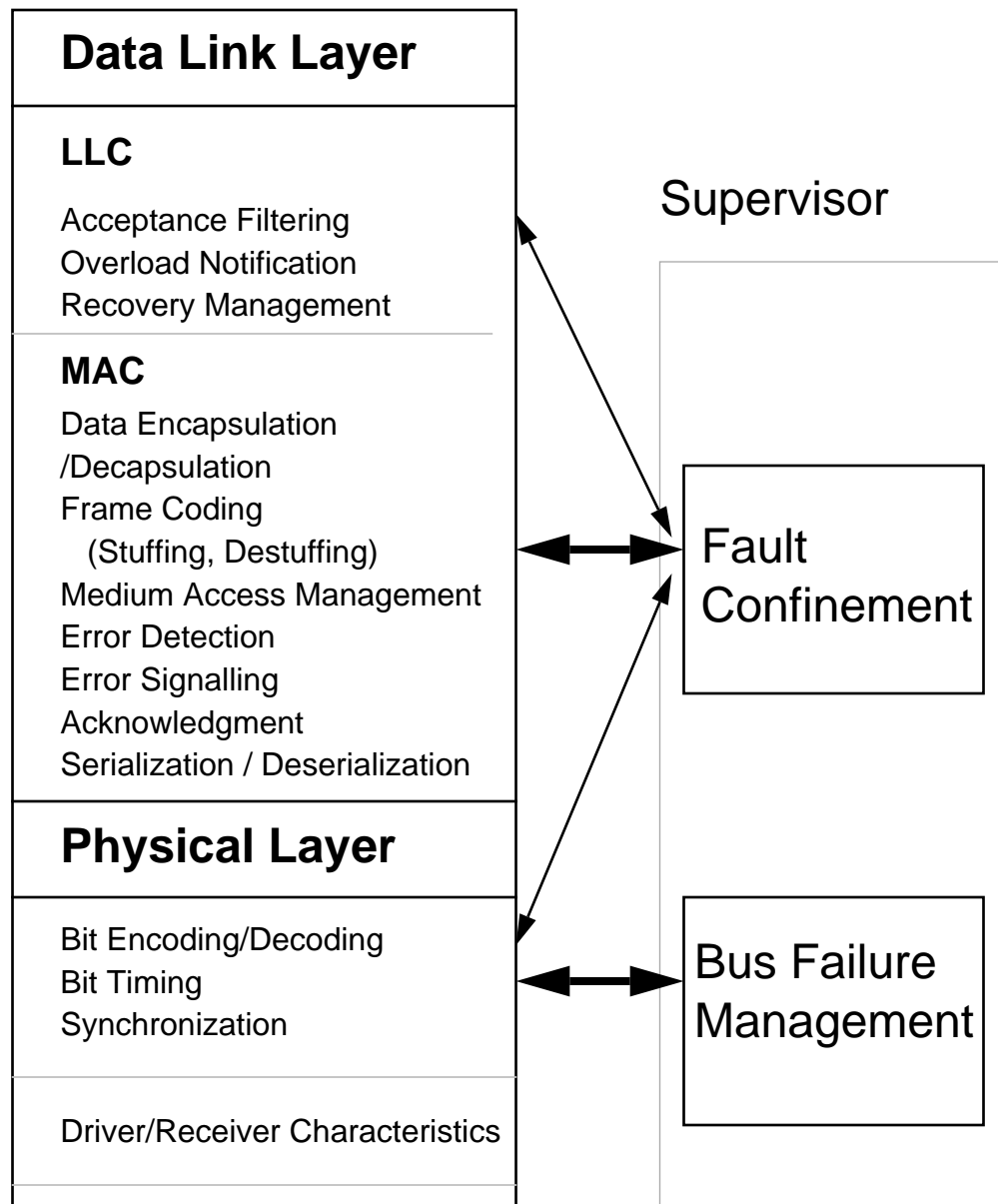

LLC = Logical Link Control
MAC = Medium Access Control

The scope of this specification is to define the Data Link Layer and the consequences of the CAN protocol on the surrounding layers.

Messages

Information on the bus is sent in fixed format messages of different but limited length (see section 3: Message Transfer). When the bus is free any connected unit may start to transmit a new message.

Information Routing

In CAN systems a CAN node does not make use of any information about the system configuration (e.g. station addresses). This has several important consequences.

System Flexibility: Nodes can be added to the CAN network without requiring any change in the software or hardware of any node and application layer.

Message Routing: The content of a message is named by an IDENTIFIER. The IDENTIFIER does not indicate the destination of the message, but describes the meaning of the data, so that all nodes in the network are able to decide by Message Filtering whether the data is to be acted upon by them or not.

Multicast: As a consequence of the concept of Message Filtering any number of nodes can receive and simultaneously act upon the same message.

Data Consistency: Within a CAN network it is guaranteed that a message is simultaneously accepted either by all nodes or by no node. Thus data consistency of a system is achieved by the concepts of multicast and by error handling.

Bit rate

The speed of CAN may be different in different systems. However, in a given system the bit-rate is uniform and fixed.

Priorities

The IDENTIFIER defines a static message priority during bus access.

Remote Data Request

By sending a REMOTE FRAME a node requiring data may request another node to send the corresponding DATA FRAME. The DATA FRAME and the corresponding REMOTE FRAME are named by the same IDENTIFIER.

Multimaster

When the bus is free any unit may start to transmit a message. The unit with the message of higher priority to be transmitted gains bus access.

Arbitration

Whenever the bus is free, any unit may start to transmit a message. If 2 or more units start transmitting messages at the same time, the bus access conflict is resolved by bitwise arbitration using the IDENTIFIER. The mechanism of arbitration guarantees that neither information nor time is lost. If a DATA FRAME and a REMOTE FRAME with the same IDENTIFIER are initiated at the same time, the DATA FRAME prevails over the REMOTE FRAME. During arbitration every transmitter compares the level of the bit transmitted with the level that is monitored on the bus. If these levels are equal the unit may continue to send. When a 'recessive' level is sent and a 'dominant' level is monitored (see Bus Values), the unit has lost arbitration and must withdraw without sending one more bit.

Safety

In order to achieve the utmost safety of data transfer, powerful measures for error detection, signalling and self-checking are implemented in every CAN node.

Error Detection

For detecting errors the following measures have been taken:

- Monitoring (transmitters compare the bit levels to be transmitted with the bit levels detected on the bus)
- Cyclic Redundancy Check
- Bit Stuffing
- Message Frame Check

Performance of Error Detection

The error detection mechanisms have the following properties:

- all global errors are detected.
- all local errors at transmitters are detected.
- up to 5 randomly distributed errors in a message are detected.
- burst errors of length less than 15 in a message are detected.
- errors of any odd number in a message are detected.



Total residual error probability for undetected corrupted messages: less than

$$\text{message error rate} * 4.7 * 10^{-11}.$$

Error Signalling and Recovery Time

Corrupted messages are flagged by any node detecting an error. Such messages are aborted and will be retransmitted automatically. The recovery time from detecting an error until the start of the next message is at most 31 bit times, if there is no further error.

Fault Confinement

CAN nodes are able to distinguish short disturbances from permanent failures. Defective nodes are switched off.

Connections

The CAN serial communication link is a bus to which a number of units may be connected. This number has no theoretical limit. Practically the total number of units will be limited by delay times and/or electrical loads on the bus line.

Single Channel

The bus consists of a single channel that carries bits. From this data resynchronization information can be derived. The way in which this channel is implemented is not fixed in this specification. E.g. single wire (plus ground), two differential wires, optical fibres, etc.

Bus values

The bus can have one of two complementary logical values: 'dominant' or 'recessive'. During simultaneous transmission of 'dominant' and 'recessive' bits, the resulting bus value will be 'dominant'. For example, in case of a wired-AND implementation of the bus, the 'dominant' level would be represented by a logical '0' and the 'recessive' level by a logical '1'. Physical states (e.g. electrical voltage, light) that represent the logical levels are not given in this specification.

Acknowledgment

All receivers check the consistency of the message being received and will acknowledge a consistent message and flag an inconsistent message.

Sleep Mode / Wake-up

To reduce the system's power consumption, a CAN-device may be set into sleep mode

without any internal activity and with disconnected bus drivers. The sleep mode is finished with a wake-up by any bus activity or by internal conditions of the system. On wake-up, the internal activity is restarted, although the MAC sublayer will be waiting for the system's oscillator to stabilize and it will then wait until it has synchronized itself to the bus activity (by checking for eleven consecutive 'recessive' bits), before the bus drivers are set to "on-bus" again.

Oscillator Tolerance

The Bit Timing requirements allow ceramic resonators to be used in applications with transmission rates of up to 125kbit/s as a rule of thumb; for a more precise evaluation refer to

Dias, S; Chapman, M;
"Impact of Bit Representation on Transport Capacity and Clock
Accuracy in Serial Data Streams",
SAE Technical Paper Series 890532, Multiplexing in Automobiles SP-773
March 1989

For the full bus speed range of the CAN protocol, a quartz oscillator is required.

3 MESSAGE TRANSFER

3.1 Frame Formats

There are two different formats which differ in the length of the IDENTIFIER field: Frames with the number of 11 bit IDENTIFIER are denoted **Standard Frames**. In contrast, frames containing 29 bit IDENTIFIER are denoted **Extended Frames**.

3.2 Frame Types

Message transfer is manifested and controlled by four different frame types:

A DATA FRAME carries data from a transmitter to the receivers.

A REMOTE FRAME is transmitted by a bus unit to request the transmission of the DATA FRAME with the same IDENTIFIER.

An ERROR FRAME is transmitted by any unit on detecting a bus error.

An OVERLOAD FRAME is used to provide for an extra delay between the preceding and the succeeding DATA or REMOTE FRAMEs.

DATA FRAMEs and REMOTE FRAMEs can be used both in **Standard Frame** Format and **Extended Frame** Format; they are separated from preceding frames by an INTERFRAME SPACE.

3.2.1 DATA FRAME

A DATA FRAME is composed of seven different bit fields:

START OF FRAME, ARBITRATION FIELD, CONTROL FIELD, DATA FIELD, CRC FIELD, ACK FIELD, END OF FRAME. The DATA FIELD can be of length zero.

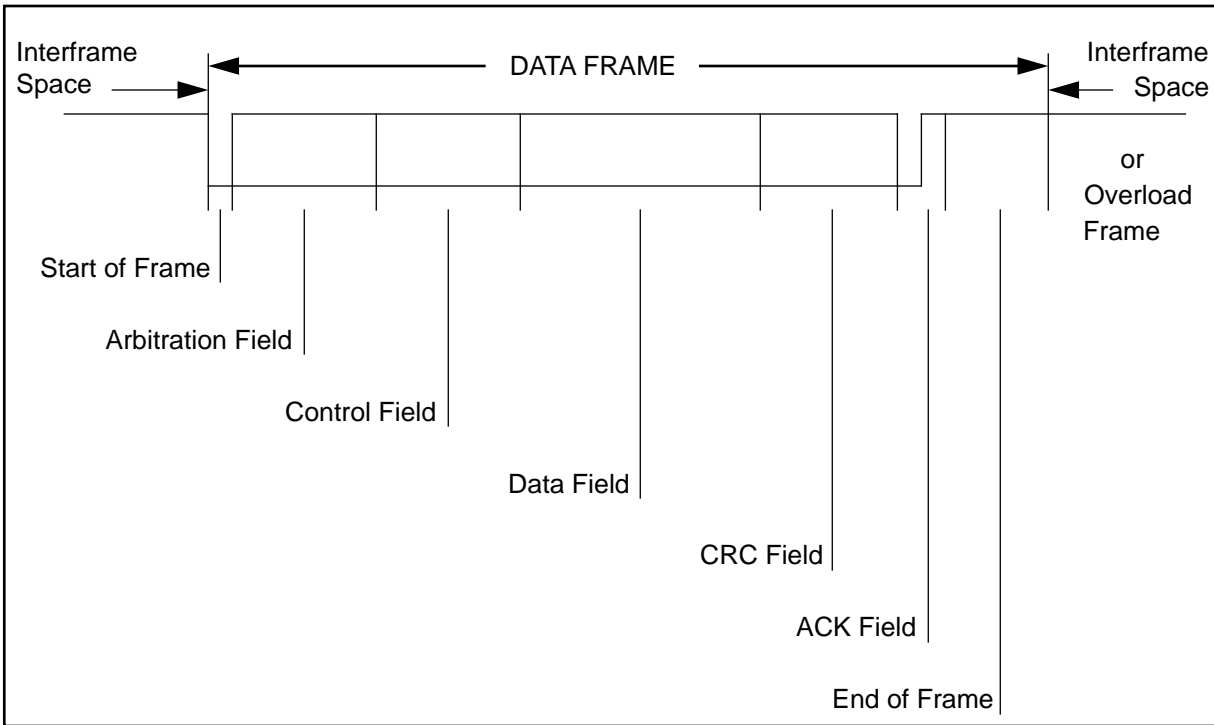

START OF FRAME (Standard Format as well as Extended Format)

The START OF FRAME (SOF) marks the beginning of DATA FRAMES and REMOTE FRAMES. It consists of a single 'dominant' bit.

A station is only allowed to start transmission when the bus is idle (see 'INTERFRAME Spacing'). All stations have to synchronize to the leading edge caused by START OF FRAME (see 'HARD SYNCHRONIZATION') of the station starting transmission first.

ARBITRATION FIELD

The format of the ARBITRATION FIELD is different for **Standard Format** and **Extended Format** Frames.

- In Standard Format the ARBITRATION FIELD consists of the 11 bit IDENTIFIER and the RTR-BIT. The IDENTIFIER bits are denoted ID-28 ... ID-18.
- In Extended Format the ARBITRATION FIELD consists of the 29 bit IDENTIFIER, the SRR-Bit, the IDE-Bit, and the RTR-BIT. The IDENTIFIER bits are denoted ID-28 ... ID-0.

In order to distinguish between Standard Format and Extended Format the reserved bit r1 in previous CAN specifications version 1.0-1.2 now is denoted as IDE Bit.

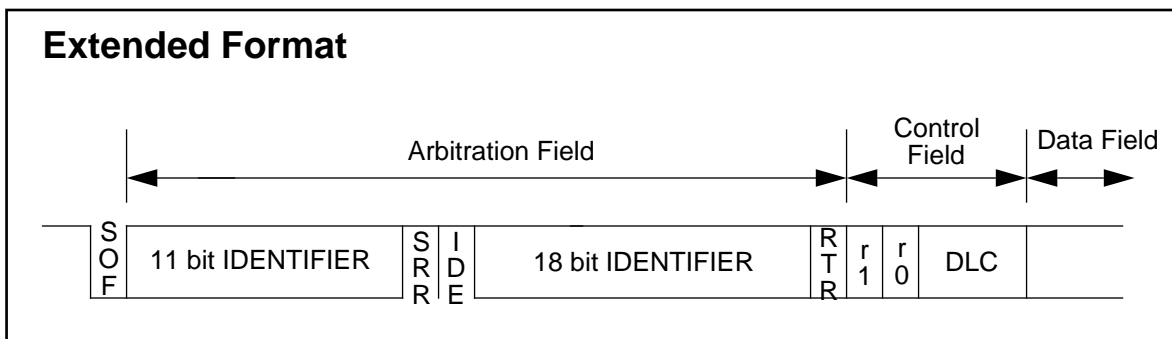
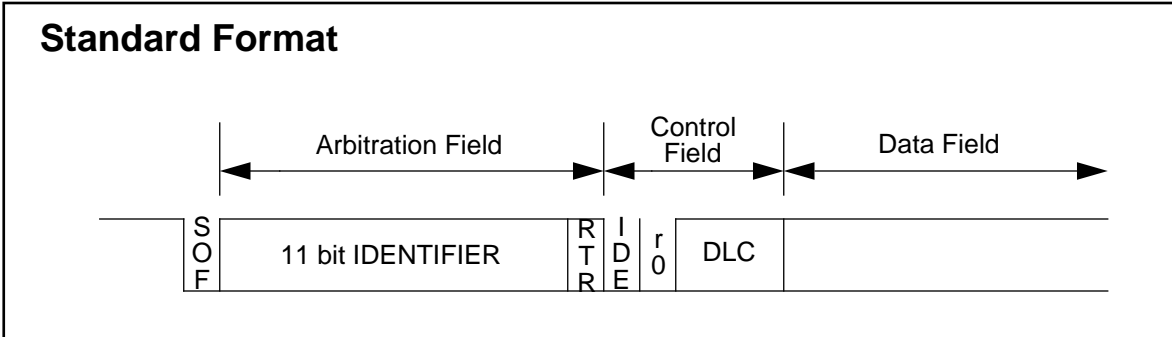

IDENTIFIER

IDENTIFIER - Standard Format

The IDENTIFIER's length is 11 bits and corresponds to the **Base ID** in **Extended Format**. These bits are transmitted in the order from ID-28 to ID-18. The least significant bit is ID-18. The 7 most significant bits (ID-28 - ID-22) must not be all 'recessive'.

IDENTIFIER - Extended Format

In contrast to the Standard Format the Extended Format consists of 29 bits. The format comprises two sections:

- Base ID** with 11 bits and the
- Extended ID** with 18 bits

**Base ID**

The Base ID consists of 11 bits. It is transmitted in the order from ID-28 to ID-18. It is equivalent to format of the Standard Identifier. The Base ID defines the Extended Frame's **base priority**.

Extended ID

The Extended ID consists of 18 bits. It is transmitted in the order of ID-17 to ID-0.

In a Standard Frame the IDENTIFIER is followed by the RTR bit.

RTR BIT (Standard Format as well as Extended Format)**Remote Transmission Request BIT**

In DATA FRAMEs the RTR BIT has to be 'dominant'. Within a REMOTE FRAME the RTR BIT has to be 'recessive'.

In an Extended Frame the Base ID is transmitted first, followed by the IDE bit and the SRR bit. The Extended ID is transmitted after the SRR bit.

SRR BIT (Extended Format)**Substitute Remote Request BIT**

The SRR is a recessive bit. It is transmitted in Extended Frames at the position of the RTR bit in Standard Frames and so substitutes the RTR-Bit in the Standard Frame.

Therefore, collisions of a Standard Frame and an Extended Frame, the Base ID (see 'Extended IDENTIFIER' below) of which is the same as the Standard Frame's Identifier, are resolved in such a way that the Standard Frame prevails the Extended Frame.

IDE BIT (Extended Format)**Identifier Extension Bit**

The IDE Bit belongs to

- the ARBITRATION FIELD for the **Extended Format**
- the Control Field for the **Standard Format**

The IDE bit in the Standard Format is transmitted 'dominant', whereas in the Extended Format the IDE bit is recessive.

CONTROL FIELD (Standard Format as well as Extended Format)

The CONTROL FIELD consists of six bits. The format of the CONTROL FIELD is different for **Standard Format** and **Extended Format**. Frames in Standard Format include the DATA LENGTH CODE, the IDE bit, which is transmitted 'dominant' (see

above), and the reserved bit r0. Frames in the Extended Format include the DATA LENGTH CODE and two reserved bits r1 and r0. The reserved bits have to be sent 'dominant', but receivers accept 'dominant' and 'recessive' bits in all combinations.

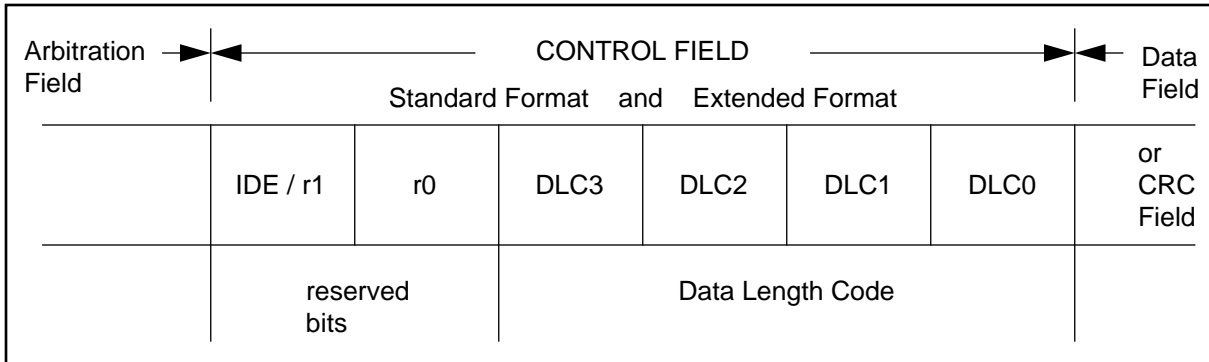

DATA LENGTH CODE (Standard Format as well as Extended Format)

The number of bytes in the DATA FIELD is indicated by the DATA LENGTH CODE. This DATA LENGTH CODE is 4 bits wide and is transmitted within the CONTROL FIELD.

Coding of the number of data bytes by the DATA LENGTH CODE abbreviations:
 d 'dominant'
 r 'recessive'

Number of Data Bytes	Data Length Code			
	DLC3	DLC2	DLC1	DLC0
0	d	d	d	d
1	d	d	d	r
2	d	d	r	d
3	d	d	r	r
4	d	r	d	d
5	d	r	d	r
6	d	r	r	d
7	d	r	r	r
8	r	d	d	d

DATA FRAME: admissible numbers of data bytes: {0,1,....,7,8}.
Other values may not be used.

DATA FIELD (Standard Format as well as Extended Format)

The DATA FIELD consists of the data to be transferred within a DATA FRAME. It can contain from 0 to 8 bytes, which each contain 8 bits which are transferred MSB first.

CRC FIELD (Standard Format as well as Extended Format)

contains the CRC SEQUENCE followed by a CRC DELIMITER.

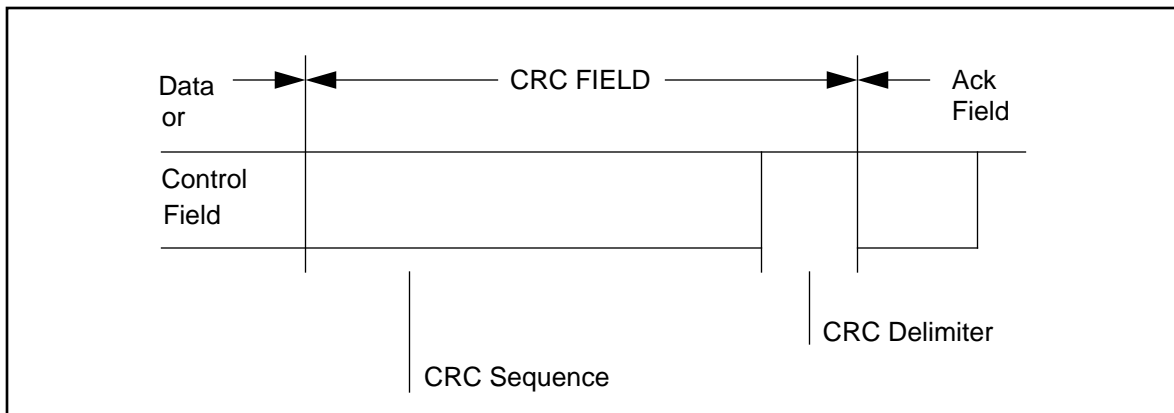

CRC SEQUENCE (Standard Format as well as Extended Format)

The frame check sequence is derived from a cyclic redundancy code best suited for frames with bit counts less than 127 bits (BCH Code).

In order to carry out the CRC calculation the polynomial to be divided is defined as the polynomial, the coefficients of which are given by the destuffed bit stream consisting of START OF FRAME, ARBITRATION FIELD, CONTROL FIELD, DATA FIELD (if present) and, for the 15 lowest coefficients, by 0. This polynomial is divided (the coefficients are calculated modulo-2) by the generator-polynomial:

$$X^{15} + X^{14} + X^{10} + X^8 + X^7 + X^4 + X^3 + 1.$$

The remainder of this polynomial division is the CRC SEQUENCE transmitted over the bus. In order to implement this function, a 15 bit shift register CRC_RG(14:0) can be used. If NXTBIT denotes the next bit of the bit stream, given by the destuffed bit sequence from START OF FRAME until the end of the DATA FIELD, the CRC SEQUENCE is calculated as follows:

```
CRC_RG = 0; // initialize shift register
```

REPEAT

```
CRCNXT = NXTBIT EXOR CRC_RG(14);  
CRC_RG(14:1) = CRC_RG(13:0);           // shift left by  
CRC_RG(0) = 0;                          // 1 position  
IF CRCNXT THEN  
    CRC_RG(14:0) = CRC_RG(14:0) EXOR (4599hex);  
ENDIF
```

UNTIL (CRC SEQUENCE starts or there is an ERROR condition)

After the transmission / reception of the last bit of the DATA FIELD, CRC_RG contains the CRC sequence.

CRC DELIMITER (Standard Format as well as Extended Format)

The CRC SEQUENCE is followed by the CRC DELIMITER which consists of a single 'recessive' bit.

ACK FIELD (Standard Format as well as Extended Format)

The ACK FIELD is two bits long and contains the ACK SLOT and the ACK DELIMITER. In the ACK FIELD the transmitting station sends two 'recessive' bits.

A RECEIVER which has received a valid message correctly, reports this to the TRANSMITTER by sending a 'dominant' bit during the ACK SLOT (it sends 'ACK').

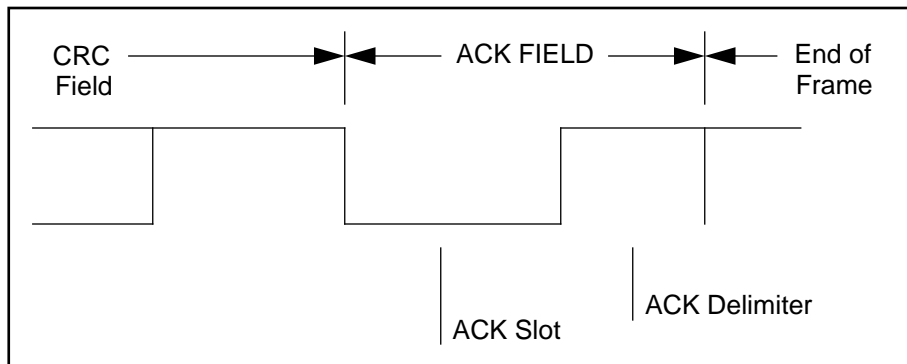
**ACK SLOT**

All stations having received the matching CRC SEQUENCE report this within the ACK SLOT by superscribing the 'recessive' bit of the TRANSMITTER by a 'dominant' bit.

ACK DELIMITER

The ACK DELIMITER is the second bit of the ACK FIELD and has to be a 'recessive' bit. As a consequence, the ACK SLOT is surrounded by two 'recessive' bits (CRC DELIMITER, ACK DELIMITER).

END OF FRAME (Standard Format as well as Extended Format)

Each DATA FRAME and REMOTE FRAME is delimited by a flag sequence consisting of seven 'recessive' bits.

3.2.2 REMOTE FRAME

A station acting as a RECEIVER for certain data can initiate the transmission of the respective data by its source node by sending a REMOTE FRAME.

A REMOTE FRAME exists in both Standard Format and Extended Format. In both cases it is composed of six different bit fields:

START OF FRAME, ARBITRATION FIELD, CONTROL FIELD, CRC FIELD, ACK FIELD, END OF FRAME.

Contrary to DATA FRAMEs, the RTR bit of REMOTE FRAMEs is 'recessive'. There is no DATA FIELD, independent of the values of the DATA LENGTH CODE which may be signed any value within the admissible range 0...8. The value is the DATA LENGTH CODE of the corresponding DATA FRAME.

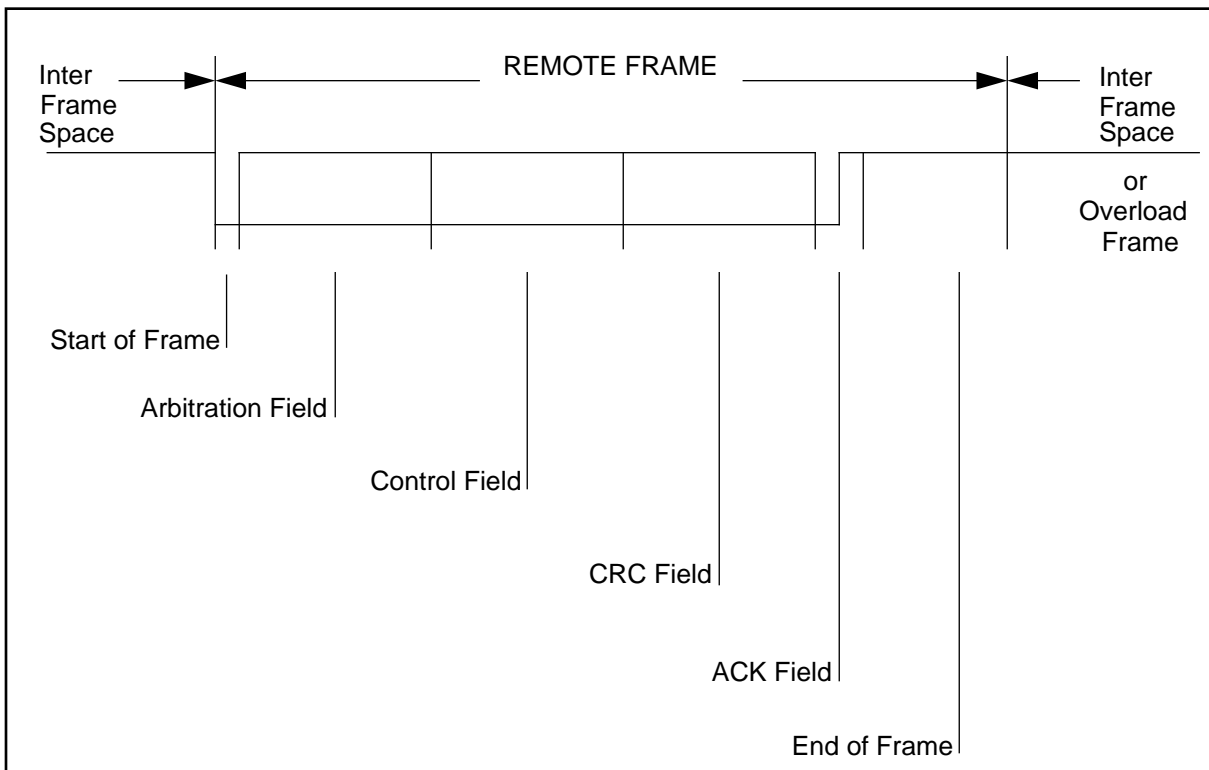

The polarity of the RTR bit indicates whether a transmitted frame is a DATA FRAME (RTR bit 'dominant') or a REMOTE FRAME (RTR bit 'recessive').

3.2.3 ERROR FRAME

The ERROR FRAME consists of two different fields. The first field is given by the superposition of ERROR FLAGS contributed from different stations. The following second field is the ERROR DELIMITER.

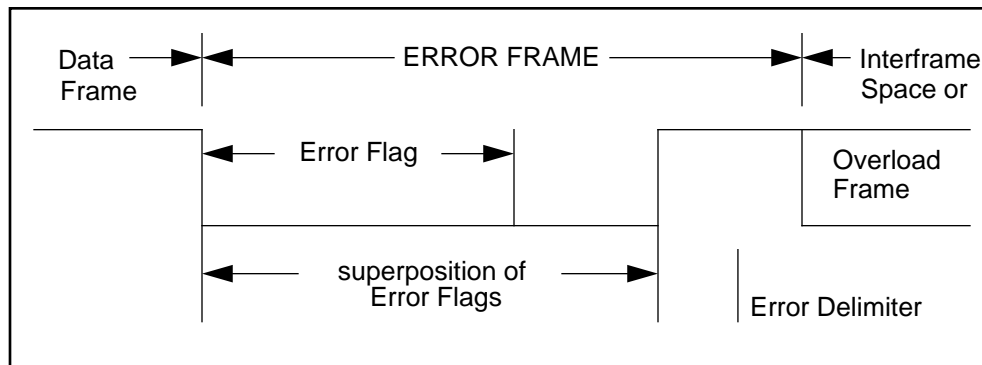

In order to terminate an ERROR FRAME correctly, an 'error passive' node may need the bus to be 'bus idle' for at least 3 bit times (if there is a local error at an 'error passive' receiver). Therefore the bus should not be loaded to 100%.

ERROR FLAG

There are 2 forms of an ERROR FLAG: an ACTIVE ERROR FLAG and a PASSIVE ERROR FLAG.

1. The ACTIVE ERROR FLAG consists of six consecutive 'dominant' bits.
2. The PASSIVE ERROR FLAG consists of six consecutive 'recessive' bits unless it is overwritten by 'dominant' bits from other nodes.

An 'error active' station detecting an error condition signals this by transmission of an ACTIVE ERROR FLAG. The ERROR FLAG's form violates the law of bit stuffing (see CODING) applied to all fields from START OF FRAME to CRC DELIMITER or destroys the fixed form ACK FIELD or END OF FRAME field. As a consequence, all other stations detect an error condition and on their part start transmission of an ERROR

FLAG. So the sequence of 'dominant' bits which actually can be monitored on the bus results from a superposition of different ERROR FLAGS transmitted by individual stations. The total length of this sequence varies between a minimum of six and a maximum of twelve bits.

An 'error passive' station detecting an error condition tries to signal this by transmission of a PASSIVE ERROR FLAG. The 'error passive' station waits for six consecutive bits of equal polarity, beginning at the start of the PASSIVE ERROR FLAG. The PASSIVE ERROR FLAG is complete when these 6 equal bits have been detected.

ERROR DELIMITER

The ERROR DELIMITER consists of eight 'recessive' bits.

After transmission of an ERROR FLAG each station sends 'recessive' bits and monitors the bus until it detects a 'recessive' bit. Afterwards it starts transmitting seven more 'recessive' bits.

3.2.4 OVERLOAD FRAME

The OVERLOAD FRAME contains the two bit fields OVERLOAD FLAG and OVERLOAD DELIMITER.

There are two kinds of OVERLOAD conditions, which both lead to the transmission of an OVERLOAD FLAG:

1. The internal conditions of a receiver, which requires a delay of the next DATA FRAME or REMOTE FRAME.
2. Detection of a 'dominant' bit at the first and second bit of INTERMISSION.
3. If a CAN node samples a dominant bit at the eighth bit (the last bit) of an ERROR DELIMITER or OVERLOAD DELIMITER, it will start transmitting an OVERLOAD FRAME (not an ERROR FRAME). The Error Counters will not be incremented.

The start of an OVERLOAD FRAME due to OVERLOAD condition 1 is only allowed to be started at the first bit time of an expected INTERMISSION, whereas OVERLOAD FRAMEs due to OVERLOAD condition 2 and condition 3 start one bit after detecting the 'dominant' bit.

At most two OVERLOAD FRAMEs may be generated to delay the next DATA or REMOTE FRAME.

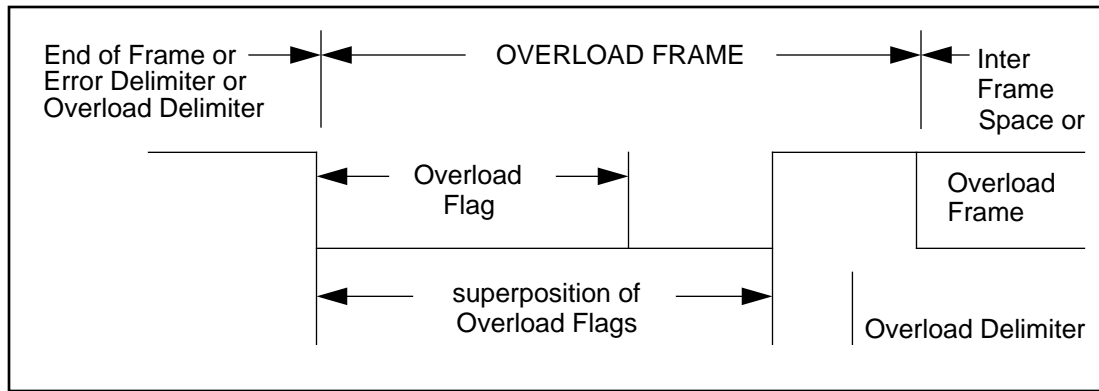

OVERLOAD FLAG

consists of six 'dominant' bits. The overall form corresponds to that of the ACTIVE ERROR FLAG.

The OVERLOAD FLAG's form destroys the fixed form of the INTERMISSION field. As a consequence, all other stations also detect an OVERLOAD condition and on their part start transmission of an OVERLOAD FLAG. In case that there is a 'dominant' bit detected during the 3rd bit of INTERMISSION then it will interpret this bit as START OF FRAME.

Note:

Controllers based on the CAN Specification version 1.0 and 1.1 have another interpretation of the 3rd bit if INTERMISSION: If a 'dominant' bit was detected locally at some node, the other nodes will not interpret the OVERLOAD FLAG correctly, but interpret the first of these six 'dominant' bits as START OF FRAME; the sixth 'dominant' bit violates the rule of bit stuffing causing an error condition.

OVERLOAD DELIMITER

consists of eight 'recessive' bits.

The OVERLOAD DELIMITER is of the same form as the ERROR DELIMITER. After transmission of an OVERLOAD FLAG the station monitors the bus until it detects a transition from a 'dominant' to a 'recessive' bit. At this point of time every bus station has finished sending its OVERLOAD FLAG and all stations start transmission of seven more 'recessive' bits in coincidence.

3.2.5 INTERFRAME SPACING

DATA FRAMEs and REMOTE FRAMEs are separated from preceding frames whatever type they are (DATA FRAME, REMOTE FRAME, ERROR FRAME, OVERLOAD FRAME) by a bit field called INTERFRAME SPACE. In contrast, OVERLOAD FRAMEs and ERROR FRAMEs are not preceded by an INTERFRAME SPACE and multiple OVERLOAD FRAMEs are not separated by an INTERFRAME SPACE.

INTERFRAME SPACE

contains the bit fields INTERMISSION and BUS IDLE and, for 'error passive' stations, which have been TRANSMITTER of the previous message, SUSPEND TRANSMISSION.

For stations which are not 'error passive' or have been RECEIVER of the previous message:

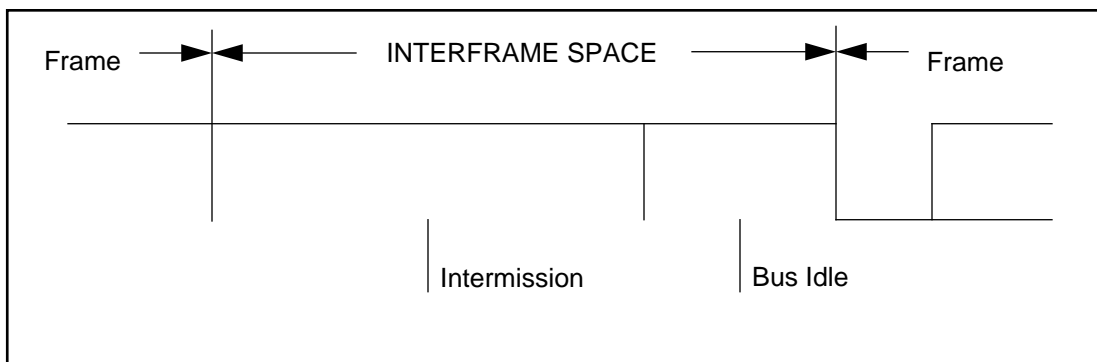

For 'error passive' stations which have been TRANSMITTER of the previous message:

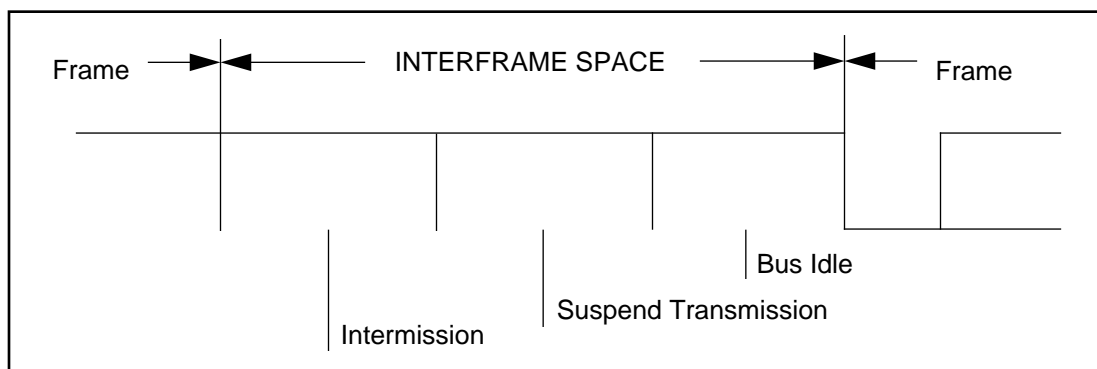
**INTERMISSION**

consists of three 'recessive' bits.

During INTERMISSION the only action to be taken is signalling an OVERLOAD condition and no station is allowed to actively start transmission of a DATA FRAME or REMOTE FRAME.

**Note:**

If a CAN node has a message waiting for transmission and it samples a dominant bit at the third bit of INTERMISSION, it will interpret this as a START OF FRAME bit, and, with the next bit, start transmitting its message with the first bit of its IDENTIFIER without first transmitting a START OF FRAME bit and without becoming receiver.

BUS IDLE

The period of BUS IDLE may be of arbitrary length. The bus is recognized to be free and any station having something to transmit can access the bus. A message, which is pending for transmission during the transmission of another message, is started in the first bit following INTERMISSION.

The detection of a 'dominant' bit on the bus is interpreted as a START OF FRAME.

SUSPEND TRANSMISSION

After an 'error passive' station has transmitted a message, it sends eight 'recessive' bits following INTERMISSION, before starting to transmit a further message or recognizing the bus to be idle. If meanwhile a transmission (caused by another station) starts, the station will become receiver of this message.

3.3 Conformance with regard to Frame Format

The Standard Format is equivalent to the Data/Remote Frame Format as it is described in the CAN Specification 1.2. In contrast the Extended Format is a new feature of the CAN protocol. In order to allow the design of relatively simple controllers, the implementation of the Extended Format to its full extend is not required (e.g. send messages or accept data from messages in Extended Format), whereas the Standard Format must be supported without restriction.

New controllers are considered to be in conformance with this CAN Specification, if they have at least the following properties with respect to the Frame Formats defined in 3.1 and 3.2:

- Every new controller supports the Standard Format;
- Every new controller can receive messages of the Extended Format. This requires that Extended Frames are not destroyed just because of their format. It is, however, not required that the Extended Format must be supported by new controllers.

3.4 Definition of TRANSMITTER / RECEIVER

TRANSMITTER

A unit originating a message is called "TRANSMITTER" of that message. The unit stays TRANSMITTER until the bus is idle or the unit loses ARBITRATION.

RECEIVER

A unit is called "RECEIVER" of a message, if it is not TRANSMITTER of that message and the bus is not idle.

4 MESSAGE FILTERING

Message filtering is based upon the whole Identifier. Optional mask registers that allow any Identifier bit to be set 'don't care' for message filtering, may be used to select groups of Identifiers to be mapped into the attached receive buffers.

If mask registers are implemented every bit of the mask registers must be programmable, i.e. they can be enabled or disabled for message filtering. The length of the mask register can comprise the whole IDENTIFIER or only part of it.

5 MESSAGE VALIDATION

The point of time at which a message is taken to be valid, is different for the transmitter and the receivers of the message.

Transmitter:

The message is valid for the transmitter, if there is no error until the end of END OF FRAME. If a message is corrupted, retransmission will follow automatically and according to prioritization. In order to be able to compete for bus access with other messages, retransmission has to start as soon as the bus is idle.

Receivers:

The message is valid for the receivers, if there is no error until the last but one bit of END OF FRAME. The value of the last bit of END OF FRAME is treated as 'don't care', a dominant value does not lead to a FORM ERROR (cf. section 7.1).

6 CODING

BIT STREAM CODING

The frame segments START OF FRAME, ARBITRATION FIELD, CONTROL FIELD, DATA FIELD and CRC SEQUENCE are coded by the method of bit stuffing. Whenever a transmitter detects five consecutive bits of identical value in the bit stream to be transmitted it automatically inserts a complementary bit in the actual transmitted bit stream.

The remaining bit fields of the DATA FRAME or REMOTE FRAME (CRC DELIMITER, ACK FIELD, and END OF FRAME) are of fixed form and not stuffed. The ERROR FRAME and the OVERLOAD FRAME are of fixed form as well and not coded by the method of bit stuffing.

The bit stream in a message is coded according to the Non-Return-to-Zero (NRZ) method. This means that during the total bit time the generated bit level is either 'dominant' or 'recessive'.

7 ERROR HANDLING

7.1 Error Detection

There are 5 different error types (which are not mutually exclusive):

- **BIT ERROR**
A unit that is sending a bit on the bus also monitors the bus. A BIT ERROR has to be detected at that bit time, when the bit value that is monitored is different from the bit value that is sent. An exception is the sending of a 'recessive' bit during the stuffed bit stream of the ARBITRATION FIELD or during the ACK SLOT. Then no BIT ERROR occurs when a 'dominant' bit is monitored. A TRANSMITTER sending a PASSIVE ERROR FLAG and detecting a 'dominant' bit does not interpret this as a BIT ERROR.
- **STUFF ERROR**
A STUFF ERROR has to be detected at the bit time of the 6th consecutive equal bit level in a message field that should be coded by the method of bit stuffing.
- **CRC ERROR**
The CRC sequence consists of the result of the CRC calculation by the transmitter. The receivers calculate the CRC in the same way as the transmitter. A CRC ERROR has to be detected, if the calculated result is not the same as that received in the CRC sequence.
- **FORM ERROR**
A FORM ERROR has to be detected when a fixed-form bit field contains one or more illegal bits. (Note, that for a Receiver a dominant bit during the last bit of END OR FRAME is not treated as FORM ERROR).
- **ACKNOWLEDGMENT ERROR**
An ACKNOWLEDGMENT ERROR has to be detected by a transmitter whenever it does not monitor a 'dominant' bit during the ACK SLOT.

7.2 Error Signalling

A station detecting an error condition signals this by transmitting an ERROR FLAG. For an 'error active' node it is an ACTIVE ERROR FLAG, for an 'error passive' node it is a PASSIVE ERROR FLAG. Whenever a BIT ERROR, a STUFF ERROR, a FORM ERROR or an ACKNOWLEDGMENT ERROR is detected by any station, transmission of an ERROR FLAG is started at the respective station at the next bit.

Whenever a CRC ERROR is detected, transmission of an ERROR FLAG starts at the bit following the ACK DELIMITER, unless an ERROR FLAG for another condition has already been started.

8 FAULT CONFINEMENT

With respect to fault confinement a unit may be in one of three states:

- 'error active'
- 'error passive'
- 'bus off'

An 'error active' unit can normally take part in bus communication and sends an ACTIVE ERROR FLAG when an error has been detected.

An 'error passive' unit must not send an ACTIVE ERROR FLAG. It takes part in bus communication, but when an error has been detected only a PASSIVE ERROR FLAG is sent. Also after a transmission, an 'error passive' unit will wait before initiating a further transmission. (See SUSPEND TRANSMISSION)

A 'bus off' unit is not allowed to have any influence on the bus. (E.g. output drivers switched off.)

For fault confinement two counts are implemented in every bus unit:

- 1) TRANSMIT ERROR COUNT
- 2) RECEIVE ERROR COUNT

These counts are modified according to the following rules:

(note that more than one rule may apply during a given message transfer)

1. When a RECEIVER detects an error, the RECEIVE ERROR COUNT will be increased by 1, except when the detected error was a BIT ERROR during the sending of an ACTIVE ERROR FLAG or an OVERLOAD FLAG.
2. When a RECEIVER detects a 'dominant' bit as the first bit after sending an ERROR FLAG the RECEIVE ERROR COUNT will be increased by 8.
3. When a TRANSMITTER sends an ERROR FLAG the TRANSMIT ERROR COUNT is increased by 8.

**Exception 1:**

If the TRANSMITTER is 'error passive' and detects an ACKNOWLEDGMENT ERROR because of not detecting a 'dominant' ACK and does not detect a 'dominant' bit while sending its PASSIVE ERROR FLAG.

Exception 2:

If the TRANSMITTER sends an ERROR FLAG because a STUFF ERROR occurred during ARBITRATION, and should have been 'recessive', and has been sent as 'recessive' but monitored as 'dominant'.

In exceptions 1 and 2 the TRANSMIT ERROR COUNT is not changed.

4. If an TRANSMITTER detects a BIT ERROR while sending an ACTIVE ERROR FLAG or an OVERLOAD FLAG the TRANSMIT ERROR COUNT is increased by 8.
5. If an RECEIVER detects a BIT ERROR while sending an ACTIVE ERROR FLAG or an OVERLOAD FLAG the RECEIVE ERROR COUNT is increased by 8.
6. Any node tolerates up to 7 consecutive 'dominant' bits after sending an ACTIVE ERROR FLAG, PASSIVE ERROR FLAG or OVERLOAD FLAG. After detecting the 14th consecutive 'dominant' bit (in case of an ACTIVE ERROR FLAG or an OVERLOAD FLAG) or after detecting the 8th consecutive 'dominant' bit following a PASSIVE ERROR FLAG, and after each sequence of additional eight consecutive 'dominant' bits every TRANSMITTER increases its TRANSMIT ERROR COUNT by 8 and every RECEIVER increases its RECEIVE ERROR COUNT by 8.
7. After the successful transmission of a message (getting ACK and no error until END OF FRAME is finished) the TRANSMIT ERROR COUNT is decreased by 1 unless it was already 0.
8. After the successful reception of a message (reception without error up to the ACK SLOT and the successful sending of the ACK bit), the RECEIVE ERROR COUNT is decreased by 1, if it was between 1 and 127. If the RECEIVE ERROR COUNT was 0, it stays 0, and if it was greater than 127, then it will be set to a value between 119 and 127.
9. A node is 'error passive' when the TRANSMIT ERROR COUNT equals or exceeds 128, or when the RECEIVE ERROR COUNT equals or exceeds 128. An error condition letting a node become 'error passive' causes the node to send an ACTIVE ERROR FLAG.



10. A node is 'bus off' when the TRANSMIT ERROR COUNT is greater than or equal to 256.
11. An 'error passive' node becomes 'error active' again when both the TRANSMIT ERROR COUNT and the RECEIVE ERROR COUNT are less than or equal to 127.
12. An node which is 'bus off' is permitted to become 'error active' (no longer 'bus off') with its error counters both set to 0 after 128 occurrence of 11 consecutive 'recessive' bits have been monitored on the bus.

Note:

An error count value greater than about 96 indicates a heavily disturbed bus. It may be of advantage to provide means to test for this condition.

Note:**Start-up / Wake-up:**

If during start-up only 1 node is online, and if this node transmits some message, it will get no acknowledgment, detect an error and repeat the message. It can become 'error passive' but not 'bus off' due to this reason.



9 OSCILLATOR TOLERANCE

A maximum oscillator tolerance of 1.58% is given and therefore the use of a ceramic resonator at a bus speed of up to 125 Kbits/s as a rule of thumb; for a more precise evaluation refer to

Dias, S; Chapman, M;
"Impact of Bit Representation on Transport Capacity and Clock
Accuracy in Serial Data Streams",
SAE Technical Paper Series 890532, Multiplexing in Automobiles SP-773
March 1989

For the full bus speed range of the CAN protocol, a quartz oscillator is required.

The chip of the CAN network with the highest requirement for its oscillator accuracy determines the oscillator accuracy which is required from all the other nodes.

Note:

Can controllers following this CAN Specification and controllers following the previous versions 1.0 and 1.1, used in one and the same network, must all be equipped with a quartz oscillator. That means ceramic resonators can only be used in a network with all the nodes of the network following CAN Protocol Specification versions 1.2 or later.

10 BIT TIMING REQUIREMENTS

NOMINAL BIT RATE

The Nominal Bit Rate is the number of bits per second transmitted in the absence of resynchronization by an ideal transmitter.

NOMINAL BIT TIME

$$\text{NOMINAL BIT TIME} = 1 / \text{NOMINAL BIT RATE}$$

The Nominal Bit Time can be thought of as being divided into separate non-overlapping time segments. These segments

- SYNCHRONIZATION SEGMENT (SYNC_SEG)
- PROPAGATION TIME SEGMENT (PROP_SEG)
- PHASE BUFFER SEGMENT1 (PHASE_SEG1)
- PHASE BUFFER SEGMENT2 (PHASE_SEG2)

form the bit time as shown in figure 1.

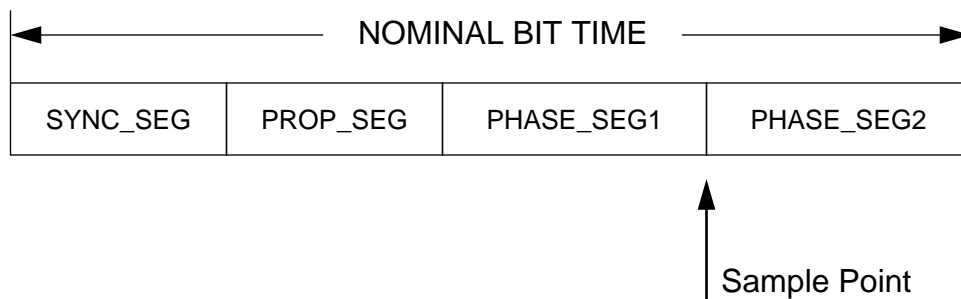

Fig. 1 Partition of the Bit Time

SYNC_SEG

This part of the bit time is used to synchronize the various nodes on the bus. An edge is expected to lie within this segment.

PROP SEG

This part of the bit time is used to compensate for the physical delay times within the network. It is twice the sum of the signal's propagation time on the bus line, the input comparator delay, and the output driver delay.

PHASE SEG1, PHASE SEG2

These Phase-Buffer-Segments are used to compensate for edge phase errors. These segments can be lengthened or shortened by resynchronization.

SAMPLE POINT

The SAMPLE POINT is the point of time at which the bus level is read and interpreted as the value of that respective bit. It's location is at the end of PHASE_SEG1.

INFORMATION PROCESSING TIME

The INFORMATION PROCESSING TIME is the time segment starting with the SAMPLE POINT reserved for calculation the subsequent bit level.

TIME QUANTUM

The TIME QUANTUM is a fixed unit of time derived from the oscillator period. There exists a programmable prescaler, with integral values, ranging at least from 1 to 32. Starting with the MINIMUM TIME QUANTUM, the TIME QUANTUM can have a length of

$$\text{TIME QUANTUM} = m * \text{MINIMUM TIME QUANTUM}$$

with m the value of the prescaler.

Length of Time Segments

- SYNC_SEG is 1 TIME QUANTUM long.
- PROP_SEG is programmable to be 1,2,...,8 TIME QUANTA long.
- PHASE_SEG1 is programmable to be 1,2,...,8 TIME QUANTA long.
- PHASE_SEG2 is the maximum of PHASE_SEG1 and the INFORMATION PROCESSING TIME
- The INFORMATION PROCESSING TIME is less than or equal to 2 TIME QUANTA long.

The total number of TIME QUANTA in a bit time has to be programmable at least from 8 to 25.

Note:

It is often intended that control units do not make use of different oscillators for the local CPU and its communication device. Therefore the oscillator frequency of a CAN device tends to be that of the local CPU and is determined by the requirements of the control unit. In order to derive the desired bitrate, programmability of the bittiming is necessary. In case of CAN implementations that are designed for use without a local CPU the bittiming cannot be programmable. On the other hand these devices allow to choose an external oscillator in such a way that the device is adjusted to the appropriate bit rate so that the programmability is dispensable for such components.

The position of the sample point, however, should be selected in common for all nodes. Therefore the bit timing of SLIO devices must be compatible to the following definition of the bit time:

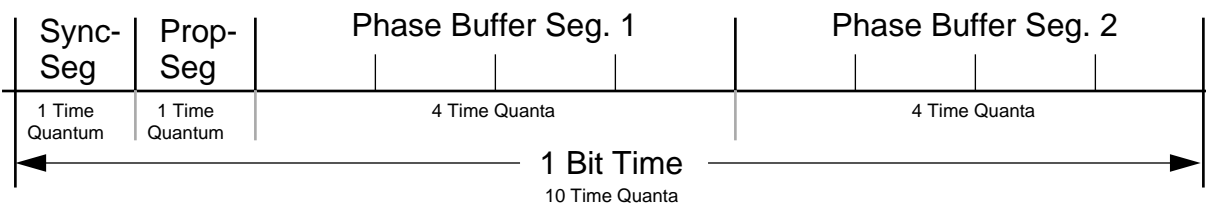
**HARD SYNCHRONIZATION**

After a HARD SYNCHRONIZATION the internal bit time is restarted with SYNC_SEG. Thus HARD SYNCHRONIZATION forces the edge which has caused the HARD SYNCHRONIZATION to lie within the SYNCHRONIZATION SEGMENT of the restarted bit time.

RESYNCHRONIZATION JUMP WIDTH

As a result of RESYNCHRONIZATION PHASE_SEG1 may be lengthened or PHASE_SEG2 may be shortened. The amount of lengthening or shortening of the PHASE BUFFER SEGMENTS has an upper bound given by the RESYNCHRONIZATION JUMP WIDTH. The RESYNCHRONIZATION JUMP WIDTH shall be programmable between 1 and $\min(4, \text{PHASE_SEG1})$.

Clocking information may be derived from transitions from one bit value to the other. The property that only a fixed maximum number of successive bits have the same value provides the possibility of resynchronizing a bus unit to the bit stream during a frame. The maximum length between two transitions which can be used for resynchronization is 29 bit times.

PHASE ERROR of an edge

The PHASE ERROR of an edge is given by the position of the edge relative to SYNC_SEG, measured in TIME QUANTA. The sign of PHASE ERROR is defined as follows:

- $e = 0$ if the edge lies within SYNC_SEG.
- $e > 0$ if the edge lies before the SAMPLE POINT.
- $e < 0$ if the edge lies after the SAMPLE POINT of the previous bit.

RESYNCHRONIZATION

The effect of a RESYNCHRONIZATION is the same as that of a HARD SYNCHRONIZATION, when the magnitude of the PHASE ERROR of the edge which causes the RESYNCHRONIZATION is less than or equal to the programmed value of the RESYNCHRONIZATION JUMP WIDTH. When the magnitude of the PHASE ERROR is larger than the RESYNCHRONIZATION JUMP WIDTH,

- and if the PHASE ERROR is positive, then PHASE_SEG1 is lengthened by an amount equal to the RESYNCHRONIZATION JUMP WIDTH.
- and if the PHASE ERROR is negative, then PHASE_SEG2 is shortened by an amount equal to the RESYNCHRONIZATION JUMP WIDTH.

SYNCHRONIZATION RULES

HARD SYNCHRONIZATION and RESYNCHRONIZATION are the two forms of SYNCHRONIZATION. They obey the following rules:

1. Only one SYNCHRONIZATION within one bit time is allowed.
2. An edge will be used for SYNCHRONIZATION only if the value detected at the previous SAMPLE POINT (previous read bus value) differs from the bus value immediately after the edge.
3. HARD SYNCHRONIZATION is performed whenever there is a 'recessive' to 'dominant' edge during BUS IDLE.
4. All other 'recessive' to 'dominant' edges fulfilling the rules 1 and 2 will be used for RESYNCHRONIZATION with the exception that a node transmitting a dominant bit will not perform a RESYNCHRONIZATION as a result of a 'recessive' to 'dominant' edge with a positive PHASE ERROR, if only 'recessive' to 'dominant' edges are used for resynchronization.



Differences

Amendment of CAN Specification 1.2 has been included in part B of this Specification. The respective alterations are marked with an asterisk.

page B-25 and page B-62:

Alteration of Fault Confinement rule 6

page B-34 to B-37:

The layered architecture of CAN was described by different layers according to the ISO/OSI Reference Model.

page B-41:*

Note to Oscillator Tolerance included

page B-43:

The numbering of the Identifier bits has been changed.

page B-51:*

According to the Oscillator Tolerance a third condition for generation of an Overload Frame was introduced.

page B-52:*

A note was added because the Interpretation of the last bit of Intermission has been changed.

page B-54:*

A note was introduced because of another interpretation of Start of Frame.

page B-55:

Section 3.3 "Conformance with regard to Frame Formats".



page B-56:

Chapter 4 "Message Filtering" was introduced recently.

page B-64:*

Note to the compatibility of the protocol modified according to the Oscillator Tolerances.

page B-67:

Note to the bittiming of implementations for ECUs without local CPU.